

VETERAN GR WRESTLING WCH - DIVISION "A"



BELGRADE (SRB)

2010-08-15 - 2010-08-15 2010

Résultats - Results

Lutte Greco-Romaine - Greco-Roman



**Liste des arbitres / Referee list****VETERAN GR WRESTLING WCH - DIVISION "A"**

N°	Licence	Pays Country	Nom - Last Name	Prénom - First Name
		AZE	QULIEV	Sadi
		BLR	BELYAKOVSKY	Alex
		BLR	VARYAVODA	Alex
		BUL	PACHEV	Ivan
		BUL	PACHEV	Toshko
		CRO	VONCHINA	Iva
		CRO	ZELICH	Josip
		EST	SAHNO	Serhey
		FIN	PETROVIC	Stevo
		GER	PFUFF	Anton
		HUN	TOMIN	Janos
		IRI	BARGHARI	Ghadir
		IRI	MOHAMMAD	Babaei
		ISR	MARKMAN	Michail
		ISR	SAPZHNIKOV	Alexe
		KAZ	ZHANPEISOV	Khairzhan
		NOR	GYUNTER	John
		NOR	MELAND	Hans
		NOR	OLSEN	Arne
		POL	DORODYAK	Bartos
		RUS	CHEPOTARYOV	Serg
		RUS	LYBINOV	Vladimir
		RUS	PROSHKIN	Sergey
		RUS	VERONIN	Pavel
		SLO	BULKO	Martin
		SRB	JOVANOVI?	Uroš
		SRB	VUKIC	Milorad
		SWE	STENBERG	Sture
		TUR	EKER	Ismail
		TUR	SOYAR	Mehmet
		TUR	YUSEL	Mehmet
		UKR	GORBATKO	Andrey
		UKR	KULISHENKO	Sergey



Liste des nations / Countries List

VETERAN GR WRESTLING WCH - DIVISION "A"

STYLE GR



Pays - Country

	ARMENIA	ARM
	BOSNIA AND HERZEGOVINA	BIH
	BULGARIA	BUL
	CROATIA	CRO
	CZECH REPUBLIC	CZE
	FINLAND	FIN
	FRANCE	FRA
	GERMANY	GER
	GREECE	GRE
	HUNGARY	HUN
	IRAN R.I.	IRI
	ITALY	ITA
	KAZAKHSTAN	KAZ
	LATVIA	LAT
	NORWAY	NOR
	RUSSIA	RUS
	SERBIA	SRB
	SWEDEN	SWE
	TURKEY	TUR
	UKRAINE	UKR
	UNITED STATES	USA

Nombre de nations - Number of Countries 21

**Nombre d'engagés par nation / Number of Entries By Country****VETERAN GR WRESTLING WCH - DIVISION "A"**

STYLE GR



<i>Pays - Country</i>	<i>58 KG</i>	<i>63 KG</i>	<i>69 KG</i>	<i>76 KG</i>	<i>85 KG</i>	<i>97 KG</i>	<i>130 KG</i>	<i>TOTAL</i>
ARM							1	1
BIH			1	1				2
BUL					1			1
CRO				1	1			2
CZE							1	1
FIN	1							1
FRA			1					1
GER		1						1
GRE					1			1
HUN				1				1
IRI	2	1	3	2	3	3	2	16
ITA					1			1
KAZ	1	2	1	1	1		1	7
LAT						1		1
NOR		1		1				2
RUS		1		2	1	3	1	8
SRB	1				1		1	3
SWE				1				1
TUR				1				1
UKR	1			1	1	1		4
USA				1				1
TOTAL	6	6	6	13	11	8	7	57

Nombre de nations - Number of Countries **21**



Liste des Engagés par pays / Entry-List By Country

VETERAN GR WRESTLING WCH - DIVISION "A"

STYLE GR



ARMENIA (ARM)

Lutteur(s) / Wrestler(s) :

130 kg

OVHANNISUA, Hrachya

BOSNIA AND HERZEGOVINA (BIH)

Lutteur(s) / Wrestler(s) :

69 kg

MARKOVIC, Dragan

76 kg

SADIKAJ, Islam

BULGARIA (BUL)

Arbitre(s) / Referee(s) :

STENBERG, Sture

Lutteur(s) / Wrestler(s) :

85 kg

KRASTEV, Krastev

CROATIA (CRO)

Lutteur(s) / Wrestler(s) :

76 kg

GRAHOVAC, Josip

85 kg

SADIKOVIC, Asmir

CZECH REPUBLIC (CZE)

Lutteur(s) / Wrestler(s) :

130 kg

ZDENEK, Kocman

FINLAND (FIN)

Arbitre(s) / Referee(s) :

OLSEN, Arne

MELAND, Hans

GYUNTER, John

Lutteur(s) / Wrestler(s) :

58 kg

TERO, Katajisto

FRANCE (FRA)

Lutteur(s) / Wrestler(s) :

69 kg

GHILNANOV, Rachid



Liste des Engagés par pays / Entry-List By Country

VETERAN GR WRESTLING WCH - DIVISION "A"



STYLE GR

GERMANY (GER)

Chef de délégation / Team Leader : BAUMEISTER, MARIO
Arbitre(s) / Referee(s) : ZHANPEISOV, Khairzhan
Lutteur(s) / Wrestler(s) :
63 kg KRUSE, Eduard

GREECE (GRE)

Chef de délégation / Team Leader : TPASKAK, KONINOE
Lutteur(s) / Wrestler(s) :
85 kg DIMITRIOS, Chalkias

HUNGARY (HUN)

Lutteur(s) / Wrestler(s) :
76 kg KALMAR, Istvan

IRAN R.I. (IRI)

Arbitre(s) / Referee(s) : BARGHARI, Ghadir
MOHAMMAD, Babaei
Lutteur(s) / Wrestler(s) :
58 kg AZIZI, A
POURMUSA, Y
63 kg HIYDARZADEH, B
69 kg HAMID, Habibi
HIYDARZADEH, S
SAFARI DIMON, Behnam
76 kg REZAEI, Hesamoldin
TAMRAZI, Ebrahim
85 kg FARSHID, Ghadimi
JAMSHIDI, Hamid
SAEEDI, Amir
97 kg BIAZARIKARI, Payman
DELAVAR-BAGHER, Zadeh
NEMATPOUR, Yousof
130 kg ANSAREFARD, M
SABORI, Azatollah

ITALY (ITA)

Lutteur(s) / Wrestler(s) :
85 kg PLACENTI, Francesco



Liste des Engagés par pays / Entry-List By Country

VETERAN GR WRESTLING WCH - DIVISION "A"



STYLE GR

KAZAKHSTAN (KAZ)

Chef de délégation / Team Leader : SERGAZIEV, KASSENKAN

NURBEKOV, NURZHAN

Arbitre(s) / Referee(s) : SAPZHNIKOV, Alexe

MARKMAN, Michail

VUKIC, Milorad

JOVANOVI?, Uroš

Lutteur(s) / Wrestler(s) :

58 kg BARYRGARA, Zhankeldi

63 kg KAIRMANOV, Nariman
NURZHAN, Nurbekov

69 kg ZHOLOMANOV, Malik

76 kg KOSVAKOV, Yertay

85 kg DEOBALD, Sergey

130 kg ZHANSUGUROV, Sotsial

LATVIA (LAT)

Chef de délégation / Team Leader : MIHAILS, BARSUKOVS

Arbitre(s) / Referee(s) : BELYAKOVSKY, Alex

VARYAVODA, Alex

YUSEL, Mehmet

EKER, Ismail

SOYAR, Mehmet

Lutteur(s) / Wrestler(s) :

97 kg DZINTARS, Urbaniciks

NORWAY (NOR)

Lutteur(s) / Wrestler(s) :

63 kg TANGEN, Francis

76 kg JORN, Melum

RUSSIA (RUS)

Chef de délégation / Team Leader : JANKOVSKI, SERGEJ

SALAKHETDINOV, TAGER

Arbitre(s) / Referee(s) : DORODYAK, Bartos

Lutteur(s) / Wrestler(s) :

63 kg ASHUGYAN, Ashot

76 kg TATARINTSEV, Alexey



Liste des Engagés par pays / Entry-List By Country

VETERAN GR WRESTLING WCH - DIVISION "A"



STYLE GR

	VAGANOV, Alexey
85 kg	KARAZHOV, Alexander
97 kg	SALIMOV, Vadif SHEGOLEV, Andrey USTINOV, Sergei
130 kg	FONAREV, Sergey

SERBIA (SRB)

Arbitre(s) / Referee(s) : BULKO, Martin

Lutteur(s) / Wrestler(s) :

58 kg	PERIC, Vasilije
85 kg	DJOKOVIC, Srdjan
130 kg	MOLNAR, Atila

SWEDEN (SWE)

Chef de délégation / Team Leader : KENNET, NORDSTROM

Arbitre(s) / Referee(s) : PROSHKIN, Sergey
LYBINOV, Vladimir
VERONIN, Pavel
CHEPOTARYOV, Serg

Lutteur(s) / Wrestler(s) :

76 kg	HEDBERG, Johan
-------	----------------

TURKEY (TUR)

Chef de délégation / Team Leader : SALIH, KARAKUS

Lutteur(s) / Wrestler(s) :

76 kg	MEHMET, Turgut
-------	----------------

UKRAINE (UKR)

Chef de délégation / Team Leader : NYLYPUK, IVAN

Entraîneur / Coach : ADYRKHAIEV, SOSLAN

Arbitre(s) / Referee(s) : PFAFF, Anton

Lutteur(s) / Wrestler(s) :

58 kg	SULIMOV, Maksym
76 kg	ZAKHARKIV, Stepan
85 kg	VASYLIEV, Ievgenii
97 kg	SARDARYAN, Aleksan



Liste des Engagés par pays / Entry-List By Country

VETERAN GR WRESTLING WCH - DIVISION "A"

STYLE GR



UNITED STATES (USA)

Chef de délégation / Team Leader : BROVN, PIVA

Lutteur(s) / Wrestler(s) :

76 kg ANTHONY, Piva



Classement

VETERAN GR WRESTLING WCH - DIVISION "A"



STYLE : GR 58 kg

1 - Or / Gold



TERO Katajisto

2 - Argent / Silver



AZIZI A

3 - Bronze



POURMUSA Y



SULIMOV Maksym

<i>Classement</i>	<i>Nom - Name</i>	<i>Pays - Country</i>
1	TERO Katajisto	FIN
2	AZIZI A	IRI
3	POURMUSA Y	IRI
3	SULIMOV Maksym	UKR
5	BARYRGARA Zhankeldi	KAZ
6	PERIC Vasilije	SRB



Feuille de compétition / Competition Sheet

VETERAN GR WRESTLING WCH - DIVISION "A"



STYLE : GR 63 kg

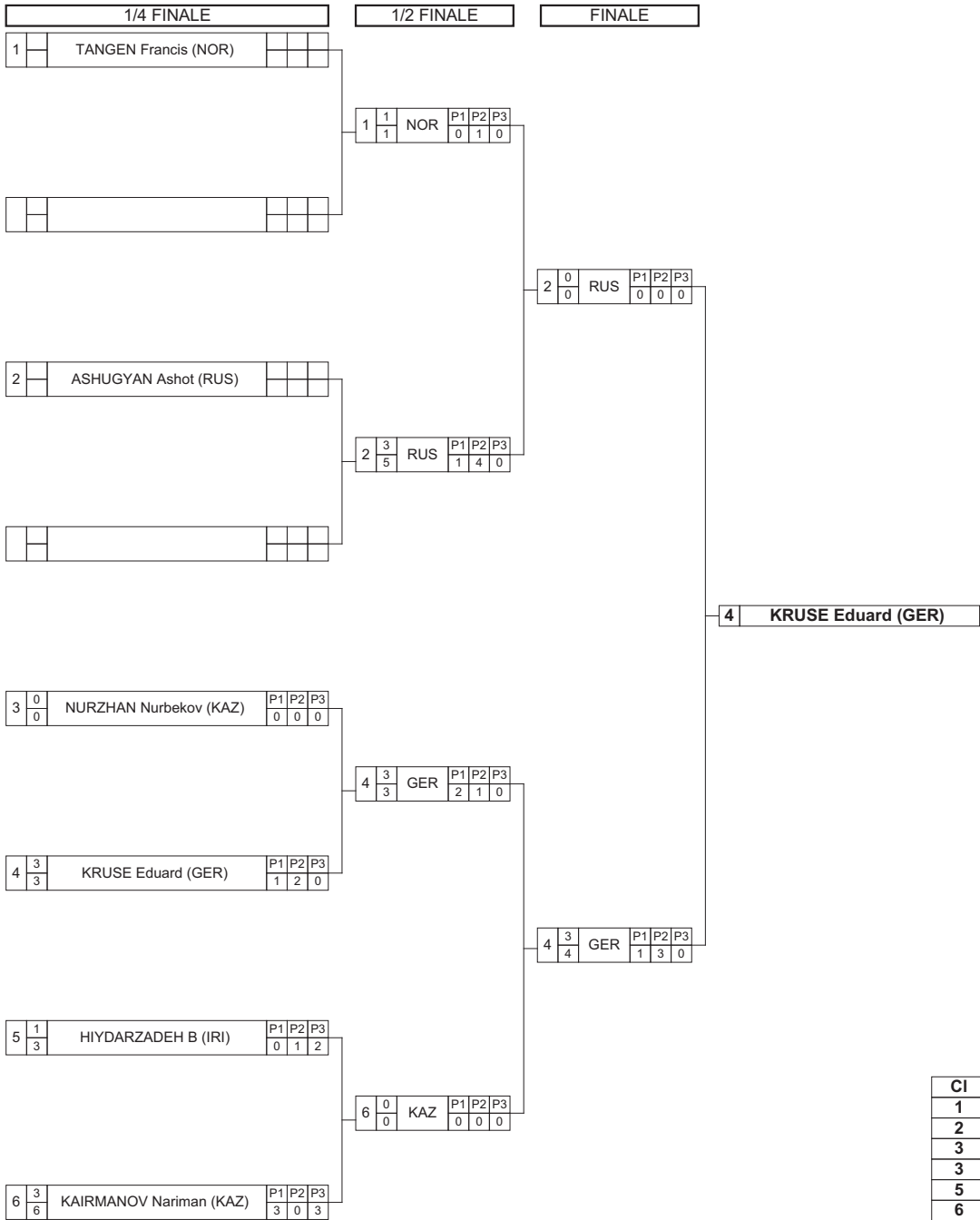

Classement

Cl	Pays	Nom
1	GER	KRUSE Eduard
2	RUS	ASHUGYAN Ashot
3	NOR	TANGEN Francis
3	KAZ	KAIRMANOV Nariman
5	KAZ	NURZHAN Nurbekov
6	IRI	HIYDARZADEH B

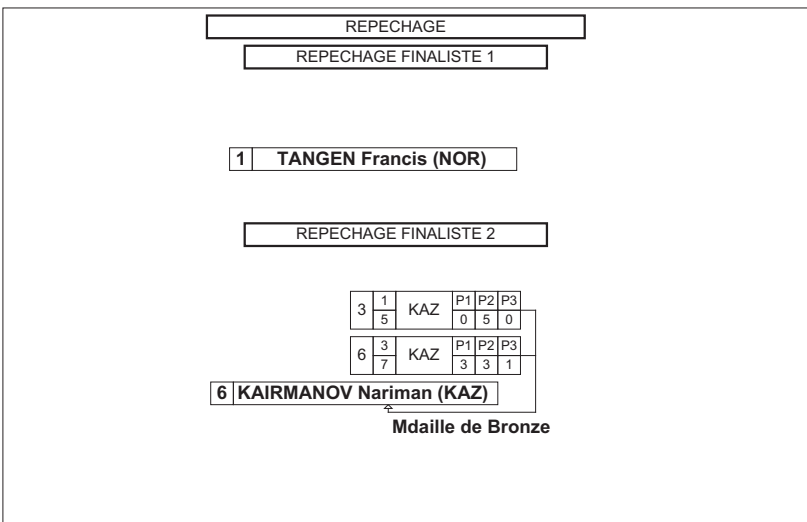



Classement

VETERAN GR WRESTLING WCH - DIVISION "A"



STYLE : GR 63 kg

1 - Or / Gold



KRUSE Eduard

2 - Argent / Silver



ASHUGYAN Ashot

3 - Bronze



TANGEN Francis



KAIRMANOV Nariman

<i>Classement</i>	<i>Nom - Name</i>	<i>Pays - Country</i>
1	KRUSE Eduard	GER
2	ASHUGYAN Ashot	RUS
3	TANGEN Francis	NOR
3	KAIRMANOV Nariman	KAZ
5	NURZHAN Nurbekov	KAZ
6	HIYDARZADEH B	IRI



Feuille de compétition / Competition Sheet

VETERAN GR WRESTLING WCH - DIVISION "A"



STYLE : GR 69 kg

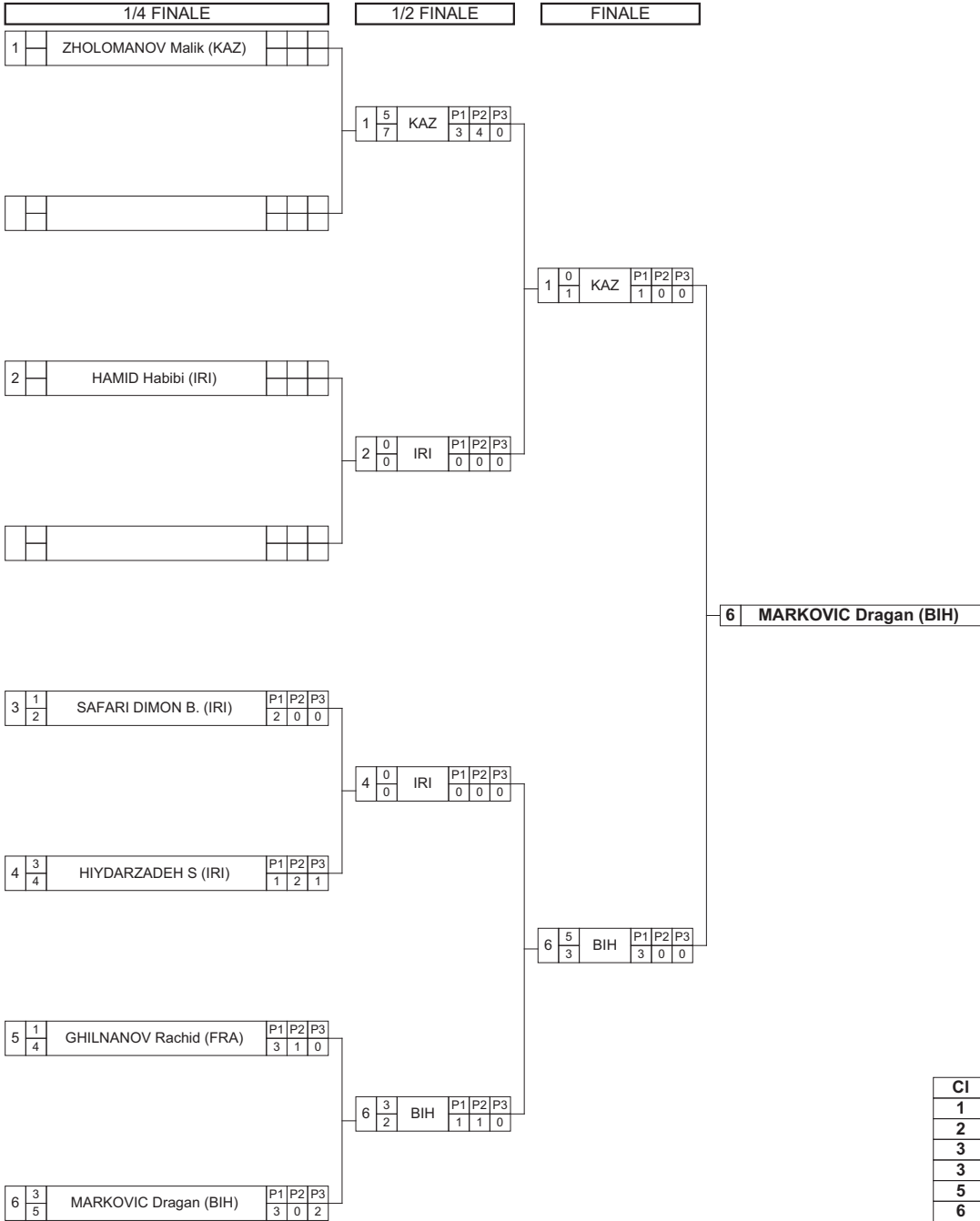

Classement

Cl	Pays	Nom
1	BIH	MARKOVIC Dragan
2	KAZ	ZHOLOMANOV Malik
3	IRI	HAMID Habibi
3	FRA	GHILNANOV Rachid
5	IRI	HIYDARZADEH S
6	IRI	SAFARI DIMON Behnam

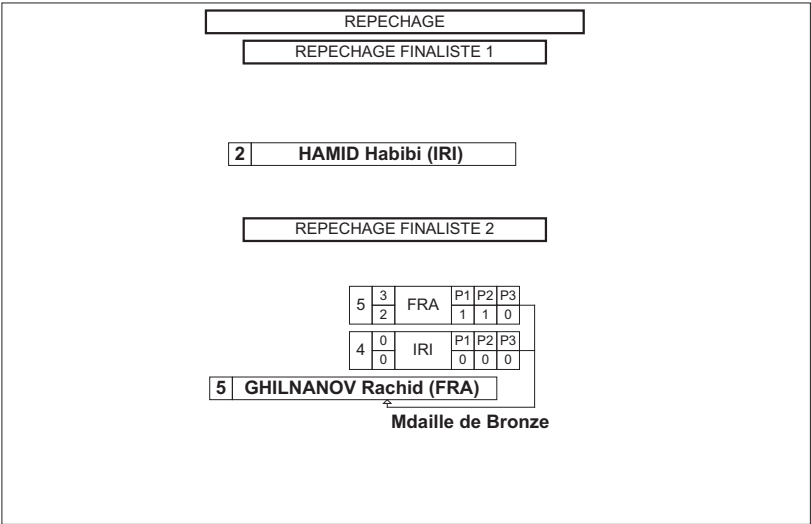



Classement

VETERAN GR WRESTLING WCH - DIVISION "A"



STYLE : GR 69 kg

1 - Or / Gold



MARKOVIC Dragan

2 - Argent / Silver



ZHOLOMANOV Malik

3 - Bronze



HAMID Habibi



GHILNANOV Rachid

<i>Classement</i>	<i>Nom - Name</i>	<i>Pays - Country</i>
1	MARKOVIC Dragan	BIH
2	ZHOLOMANOV Malik	KAZ
3	HAMID Habibi	IRI
3	GHILNANOV Rachid	FRA
5	HIYDARZADEH S	IRI
6	SAFARI DIMON Behnam	IRI



Feuille de compétition / Competition Sheet

VETERAN GR WRESTLING WCH - DIVISION "A"



STYLE : GR 76 kg



Classement

Cl	Pays	Nom
1	SWE	HEDBERG Johan
2	IRI	REZAEI Hesamoldin
3	NOR	JORN Melum
3	RUS	VAGANOV Alexey
5	KAZ	KOSVAKOV Yertay
5	BIH	SADIKAJ Islam
7	RUS	TATARINTSEV Alexey
8	USA	ANTHONY Piva
9	UKR	ZAKHARKIV Stepan
10	TUR	MEHMET Turgut
10	IRI	TAMRAZI Ebrahim
12	CRO	GRAHOVAC Josip
13	HUN	KALMAR Istvan

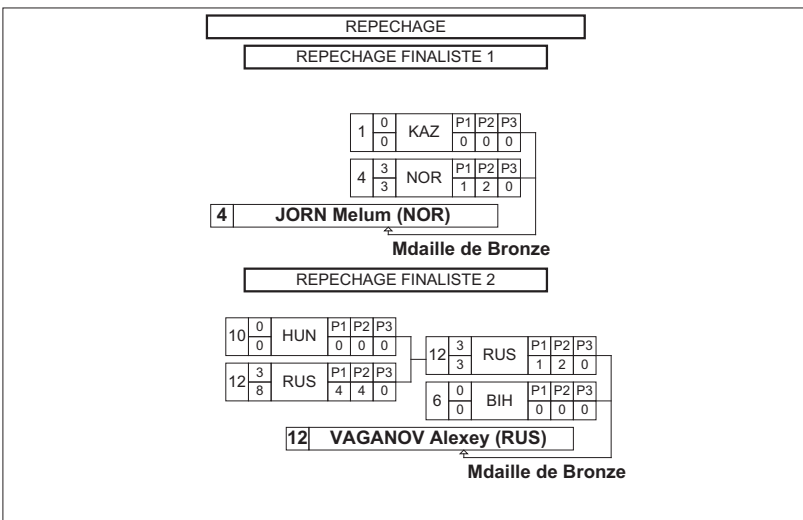



Classement

VETERAN GR WRESTLING WCH - DIVISION "A"

STYLE : GR 76 kg



1 - Or / Gold



HEDBERG Johan

2 - Argent / Silver



REZAEI Hesamoldin

3 - Bronze



JORN Melum



VAGANOV Alexey

Classement	Nom - Name	Pays - Country
1	HEDBERG Johan	SWE
2	REZAEI Hesamoldin	IRI
3	JORN Melum	NOR
3	VAGANOV Alexey	RUS
5	KOSVAKOV Yertay	KAZ
5	SADIKAJ Islam	BIH
7	TATARINTSEV Alexey	RUS
8	ANTHONY Piva	USA
9	ZAKHARKIV Stepan	UKR
10	MEHMET Turgut	TUR
10	TAMRAZI Ebrahim	IRI
12	GRAHOVAC Josip	CRO
13	KALMAR Istvan	HUN



Feuille de compétition / Competition Sheet

VETERAN GR WRESTLING WCH - DIVISION "A"



STYLE : GR 85 kg

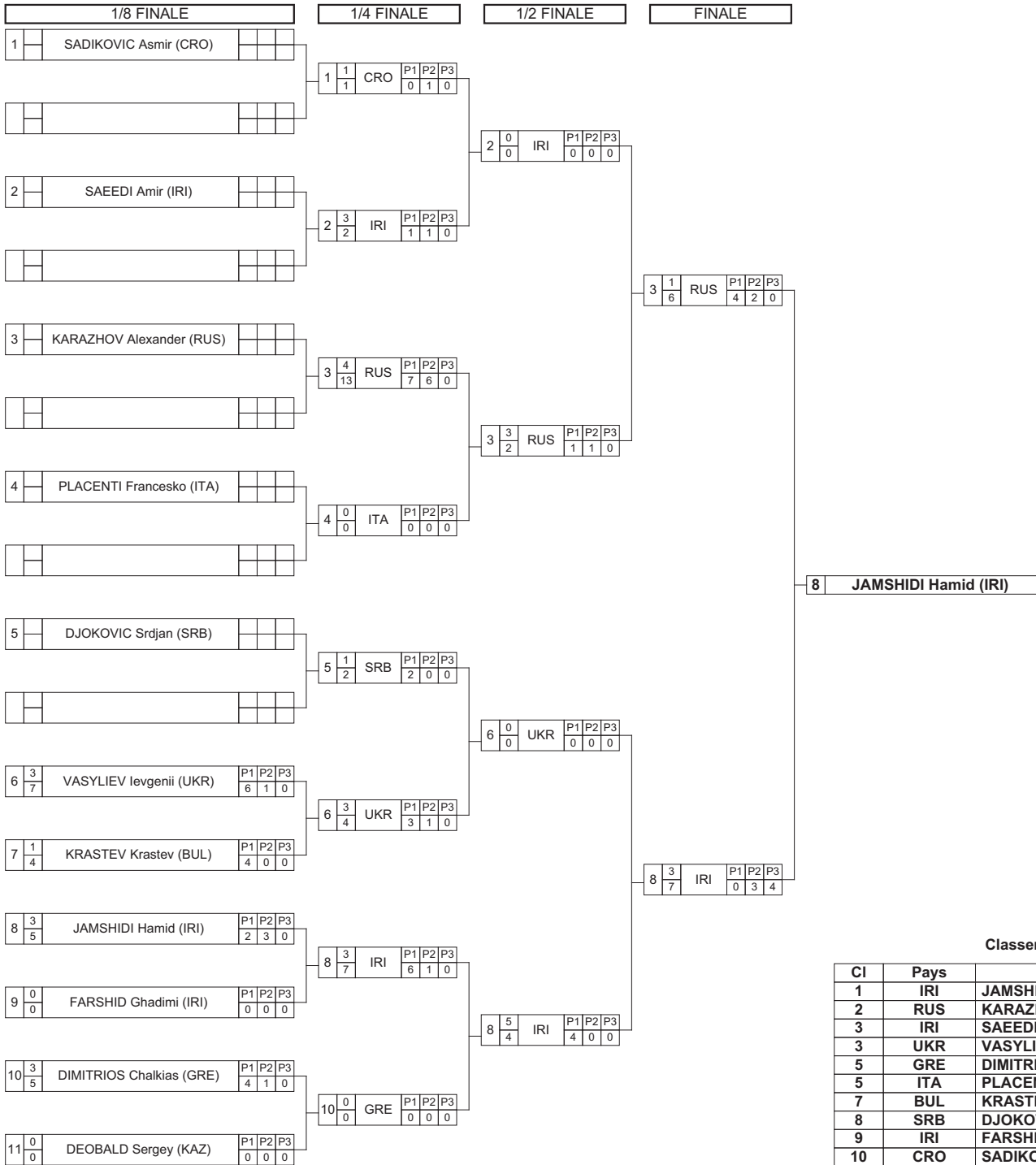

Classement

Cl	Pays	Nom
1	IRI	JAMSHIDI Hamid
2	RUS	KARAZHOV Alexander
3	IRI	SAEEDI Amir
3	UKR	VASYLIEV Ievgenii
5	GRE	DIMITRIOS Chalkias
5	ITA	PLACENTI Francesco
7	BUL	KRASTEV Krastev
8	SRB	DJOKOVIC Srdjan
9	IRI	FARSHID Ghadimi
10	CRO	SADIKOVIC Asmir
11	KAZ	DEOBALD Sergey

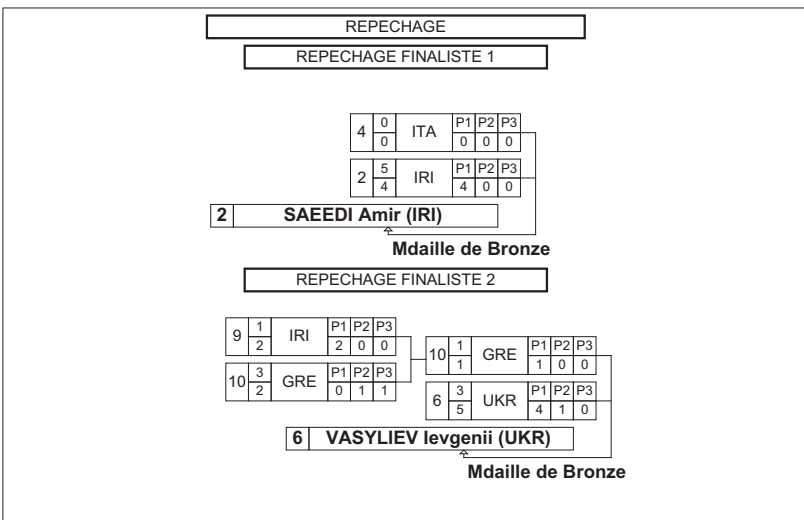



Classement

VETERAN GR WRESTLING WCH - DIVISION "A"

STYLE : GR 85 kg



1 - Or / Gold



JAMSHIDI Hamid

2 - Argent / Silver



KARAZHOV Alexander

3 - Bronze



SAEEDI Amir



VASYLIEV Ievgenii

Classement	Nom - Name	Pays - Country
1	JAMSHIDI Hamid	IRI
2	KARAZHOV Alexander	RUS
3	SAEEDI Amir	IRI
3	VASYLIEV Ievgenii	UKR
5	DIMITRIOS Chalkias	GRE
5	PLACENTI Francesko	ITA
7	KRASTEV Krastev	BUL
8	DJOKOVIC Srdjan	SRB
9	FARSHID Ghadimi	IRI
10	SADIKOVIC Asmir	CRO
11	DEOBALD Sergey	KAZ



Feuille de compétition / Competition Sheet

VETERAN GR WRESTLING WCH - DIVISION "A"



STYLE : GR 97 kg

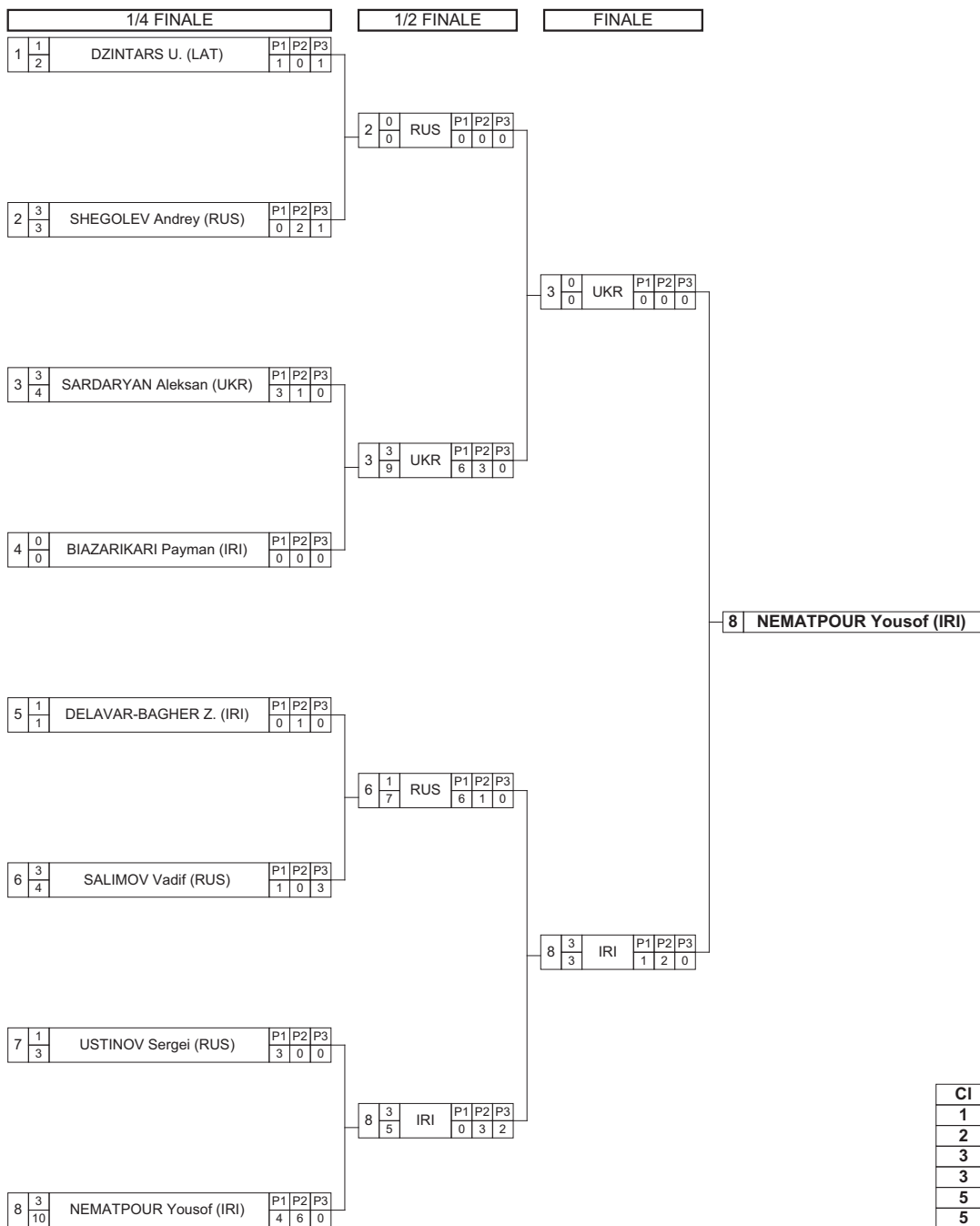

Classement

Cl	Pays	Nom
1	IRI	NEMATPOUR Yousof
2	UKR	SARDARYAN Aleksan
3	RUS	SHEGOLEV Andrey
3	RUS	USTINOV Sergei
5	IRI	BIAZARIKARI Payman
5	RUS	SALIMOV Vadif
7	LAT	DZINTARS Urbaniciks
8	IRI	DELAVAR-BAGHER Zadeh

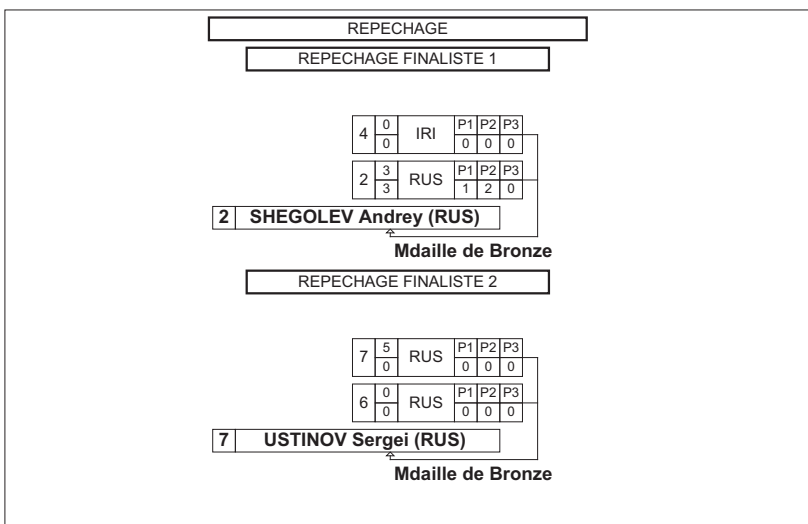



Classement

VETERAN GR WRESTLING WCH - DIVISION "A"



STYLE : GR 97 kg

1 - Or / Gold



NEMATPOUR Yousof

2 - Argent / Silver



SARDARYAN Aleksan

3 - Bronze



SHEGOLEV Andrey



USTINOV Sergei

<i>Classement</i>	<i>Nom - Name</i>	<i>Pays - Country</i>
1	NEMATPOUR Yousof	IRI
2	SARDARYAN Aleksan	UKR
3	SHEGOLEV Andrey	RUS
3	USTINOV Sergei	RUS
5	BIAZARIKARI Payman	IRI
5	SALIMOV Vadif	RUS
7	DZINTARS Urbaniciks	LAT
8	DELAVAR-BAGHER Z.	IRI



Feuille de compétition / Competition Sheet

VETERAN GR WRESTLING WCH - DIVISION "A"



STYLE : GR 130 kg



Classement

Cl	Pays	Nom
1	IRI	ANSAREFARD M
2	CZE	ZDENEK Kocman
3	IRI	SABORI Azatollah
3	RUS	FONAREV Sergey
5	ARM	OVHANNISUA Hrachya
5	SRB	MOLNAR Atila
7	KAZ	ZHANSUGUROV Sotsial

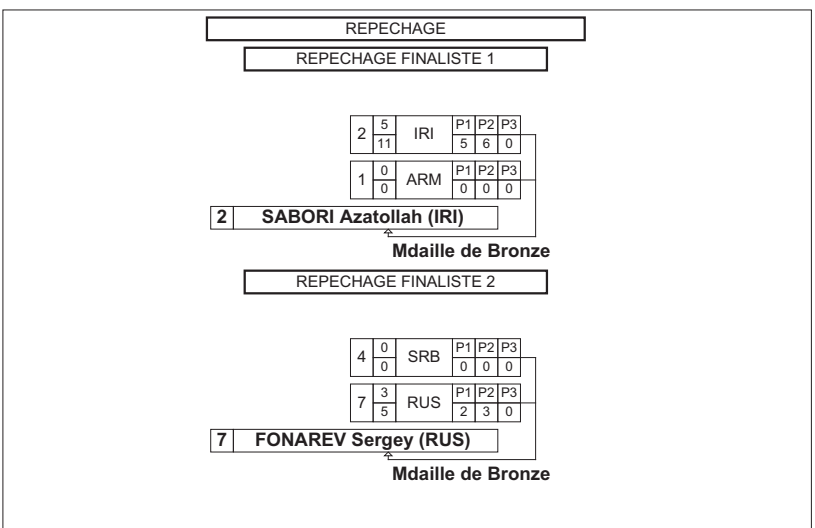



Classement

VETERAN GR WRESTLING WCH - DIVISION "A"

STYLE : GR 130 kg



1 - Or / Gold



ANSAREFARD M

2 - Argent / Silver



ZDENEK Kocman

3 - Bronze



SABORI Azatollah



FONAREV Sergey

Classement	Nom - Name	Pays - Country
1	ANSAREFARD M	IRI
2	ZDENEK Kocman	CZE
3	SABORI Azatollah	IRI
3	FONAREV Sergey	RUS
5	OVHANNISUA Hrachya	ARM
5	MOLNAR Atila	SRB
7	ZHANSUGUROV Sotsial	KAZ

VETERAN GR WRESTLING WCH - DIVISION "B"



BELGRADE (SRB)

2010-08-14 - 2010-08-14 2010

Résultats - Results

Lutte Greco-Romaine - Greco-Roman





Liste des arbitres / Referee list

VETERAN GR WRESTLING WCH - DIVISION "B"



<i>N°</i>	<i>Licence</i>	<i>Pays Country</i>	<i>Nom - Last Name</i>	<i>Prénom - First Name</i>
-----------	----------------	-------------------------	------------------------	----------------------------





Liste des nations / Countries List

VETERAN GR WRESTLING WCH - DIVISION "B"

STYLE GR



Pays - Country

	BULGARIA	BUL
	CROATIA	CRO
	ESTONIA	EST
	FINLAND	FIN
	FRANCE	FRA
	GERMANY	GER
	HUNGARY	HUN
	IRAN R.I.	IRI
	ITALY	ITA
	NORWAY	NOR
	RUSSIA	RUS
	SERBIA	SRB
	SLOVENIA	SLO
	SWEDEN	SWE
	TURKEY	TUR
	UKRAINE	UKR
	UNITED STATES	USA

Nombre de nations - Number of Countries 17

**Nombre d'engagés par nation / Number of Entries By Country****VETERAN GR WRESTLING WCH - DIVISION "B"**

STYLE GR



<i>Pays - Country</i>	<i>58 KG</i>	<i>63 KG</i>	<i>69 KG</i>	<i>76 KG</i>	<i>85 KG</i>	<i>97 KG</i>	<i>130 KG</i>	<i>TOTAL</i>
BUL	3	1	1					5
CRO		1				1		2
EST				1			2	3
FIN				1		1		2
FRA				1				1
GER				1	1			2
HUN		1	1				2	4
IRI	3	1	5	3	1	4	2	19
ITA				1				1
NOR	1			1	2			4
RUS	1	1	2		3	2	1	10
SLO			1					1
SRB		1			1			2
SWE			1	1			1	3
TUR				1			2	3
UKR		1				1		2
USA						2		2
TOTAL	8	7	11	11	8	11	10	66

Nombre de nations - Number of Countries 17



Liste des Engagés par pays / Entry-List By Country

VETERAN GR WRESTLING WCH - DIVISION "B"

STYLE GR



BULGARIA (BUL)

Lutteur(s) / Wrestler(s) :

58 kg	DIMCHO, Bonev PRAMATAROV, Svetoslav SASHO STOYANOV, Marinov
63 kg	PILIKYAN NURAN, Kapriel
69 kg	BUDINOV, Emil

CROATIA (CRO)

Lutteur(s) / Wrestler(s) :

63 kg	MARGIC, Stjepan
97 kg	RABIC, Sinisa

ESTONIA (EST)

Lutteur(s) / Wrestler(s) :

76 kg	JEVSEJEV, Andrei
130 kg	SEITON, Tiit USPENSKI, Aap

FINLAND (FIN)

Lutteur(s) / Wrestler(s) :

76 kg	SAARI, Jukka
97 kg	KETONEN, Jussi

FRANCE (FRA)

Lutteur(s) / Wrestler(s) :

76 kg	FRIDIRIK, Paul
-------	----------------

GERMANY (GER)

Lutteur(s) / Wrestler(s) :

76 kg	DEMMLER, Marcus
85 kg	TEOFANIS, Kyriakos

HUNGARY (HUN)

Lutteur(s) / Wrestler(s) :



Liste des Engagés par pays / Entry-List By Country

VETERAN GR WRESTLING WCH - DIVISION "B"



STYLE GR

63 kg	BUBORI, Antal
69 kg	LORANT, Donko
130 kg	DEZSERECKI, Istvan TURAK, Pal

IRAN R.I. (IRI)

Lutteur(s) / Wrestler(s) :

58 kg	AHADIKALASHI, Ebrahim AZIM, Hemmati JALALI, A
63 kg	MOHAMMADI K.M., Reza
69 kg	GHANBARI, Rahim KHORRAMDEL, M.R. MOHAMMAD, Aghayan MUHAMMADI FARD, Hadi YOUSEFI, Mikaeil
76 kg	DEHBOZORGE, R. HOSHANG SOLIMANI, Amir SADEGHI, Assadollah
85 kg	SOTODEH, M.B.
97 kg	AHMADZADEN, Ghader HEIDARZADEH, Abdoljabar KHAJEHVAND, H. YOUSEF, Torabi
130 kg	ALIAKBAR, Jirsareal HOSSEIN, Kazemi

ITALY (ITA)

Lutteur(s) / Wrestler(s) :

76 kg	MOLFINO, Jonathan
-------	-------------------

NORWAY (NOR)

Lutteur(s) / Wrestler(s) :

58 kg	BARD, Fornebo
76 kg	JOHANNESSEN, Andre
85 kg	ANDERSEN, Roy B. DALSBOTTEN, Martin

RUSSIA (RUS)

Lutteur(s) / Wrestler(s) :

58 kg	ASHUGYAN, Andrannik
-------	---------------------



Liste des Engagés par pays / Entry-List By Country

VETERAN GR WRESTLING WCH - DIVISION "B"



STYLE GR

63 kg	CHISTYAKOV, Alexey
69 kg	DIDENKO, Evgeny SMIRNOV, Alexandr
85 kg	DENISOV, Pavel OCHIGAVA, Kobar SERGEEV, Alexandr
97 kg	MEDVEDEV, Boris NAGAEV, Ibragim
130 kg	TASHILIN, Oleg

SERBIA (SRB)

Lutteur(s) / Wrestler(s) :

63 kg	RIZVANOVIC, Senad
85 kg	PRIKIDANOVIC, Igor

SLOVENIA (SLO)

Lutteur(s) / Wrestler(s) :

69 kg	TRBULIN, Milos
-------	----------------

SWEDEN (SWE)

Lutteur(s) / Wrestler(s) :

69 kg	OLSSON, Nicklas
76 kg	SJOEGVIST, Roger
130 kg	SANDBERG, Stefan

TURKEY (TUR)

Lutteur(s) / Wrestler(s) :

76 kg	AMILDIZ, Ercan
130 kg	AHMET, Ozbege BAL, Erdal

UKRAINE (UKR)

Lutteur(s) / Wrestler(s) :

63 kg	ZHYTOVOZ, Mykola
97 kg	OHLOBLIN, Volodymyr



Liste des Engagés par pays / Entry-List By Country

VETERAN GR WRESTLING WCH - DIVISION "B"

STYLE GR



UNITED STATES (USA)

Lutteur(s) / Wrestler(s) :

97 kg

AYERS RONALD, Sean
JEFFERYE, Anderson



Feuille de compétition / Competition Sheet

VETERAN GR WRESTLING WCH - DIVISION "B"



STYLE : GR 58 kg

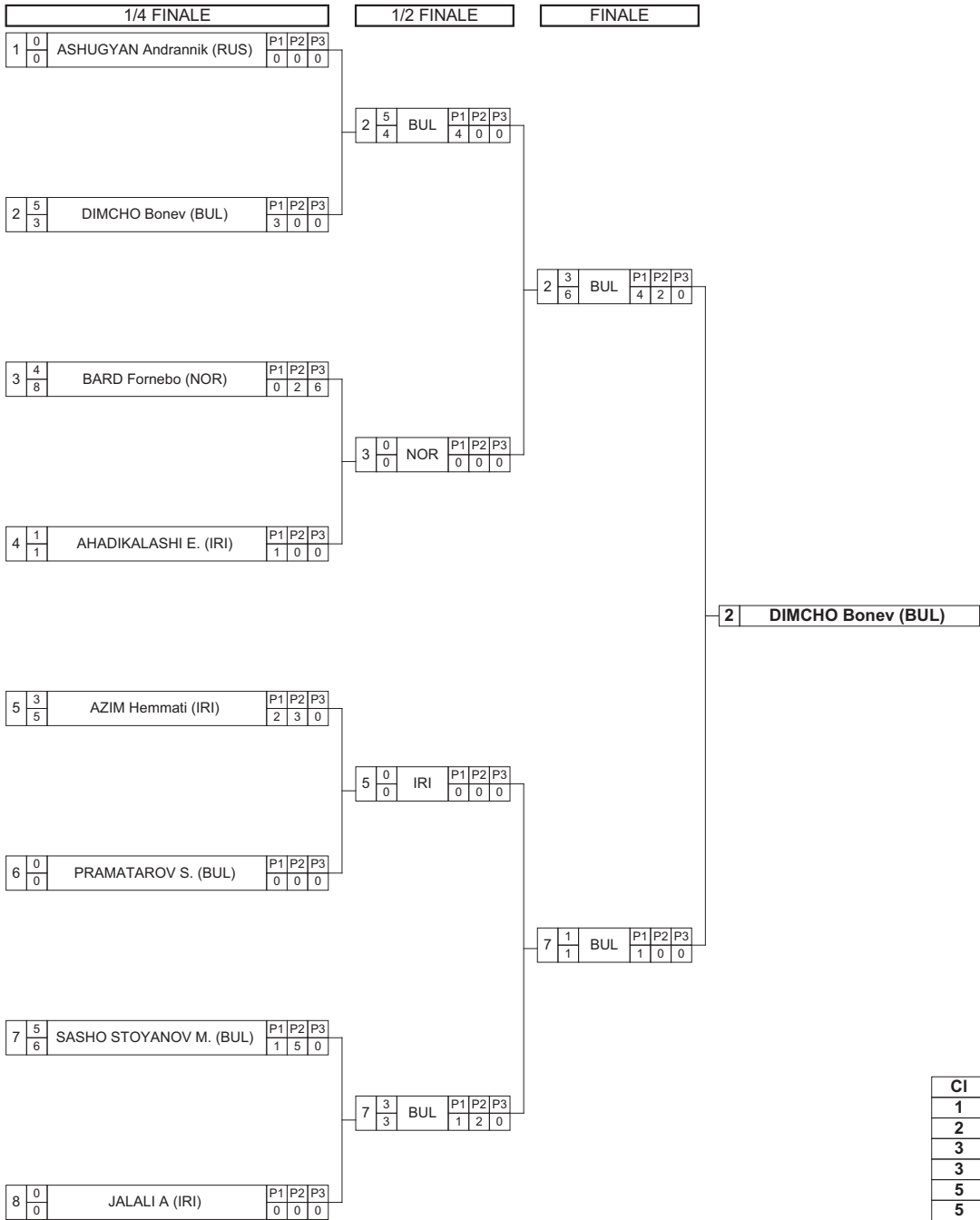

Classement

Cl	Pays	Nom
1	BUL	DIMCHO Bonev
2	BUL	SASHO STOYANOV Marinov
3	IRI	JALALI A
3	NOR	BARD Fornebo
5	RUS	ASHUGYAN Andrannik
5	IRI	AZIM Hemmati
7	BUL	PRAMATAROV Svetoslav
8	IRI	AHADIKALASHI Ebrahim

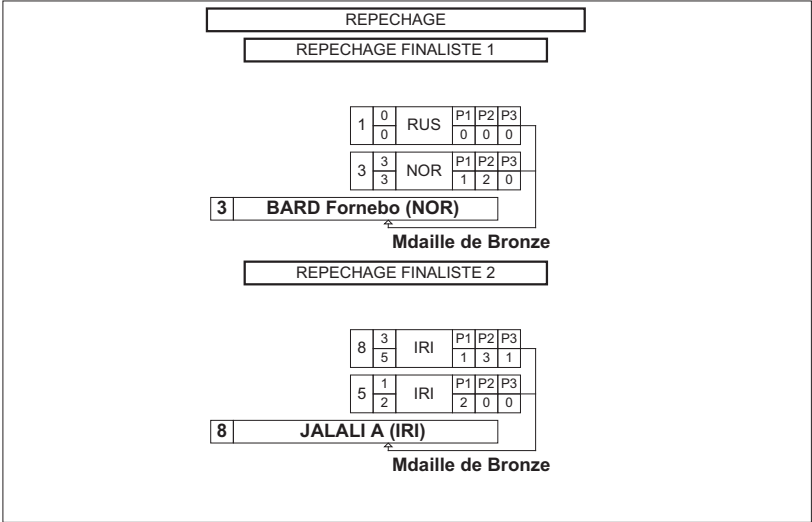



Classement

VETERAN GR WRESTLING WCH - DIVISION "B"

STYLE : GR 58 kg



1 - Or / Gold



DIMCHO Bonev

2 - Argent / Silver



SASHO STOYANOV Marinov

3 - Bronze



JALALI A



BARD Fornebo

Classement	Nom - Name	Pays - Country
1	DIMCHO Bonev	BUL
2	SASHO STOYANOV M.	BUL
3	JALALI A	IRI
3	BARD Fornebo	NOR
5	ASHUGYAN Andrannik	RUS
5	AZIM Hemmati	IRI
7	PRAMATAROV S.	BUL
8	AHADIKALASHI E.	IRI



Feuille de compétition / Competition Sheet

VETERAN GR WRESTLING WCH - DIVISION "B"

STYLE : GR 63 kg

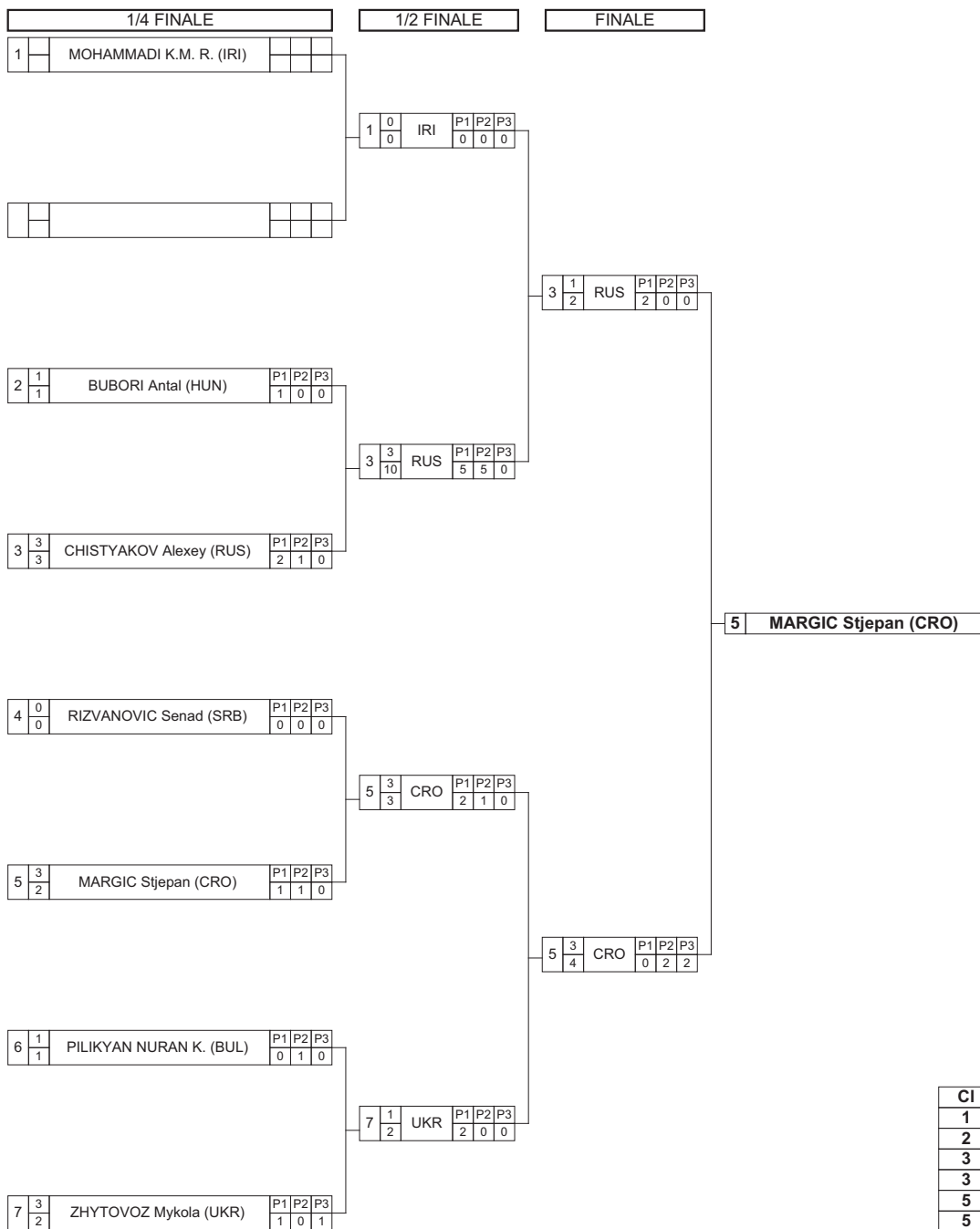

Classement

Cl	Pays	Nom
1	CRO	MARGIC Stjepan
2	RUS	CHISTYAKOV Alexey
3	HUN	BUBORI Antal
3	SRB	RIZVANOVIC Senad
5	IRI	MOHAMMADI K.M. Reza
5	UKR	ZHYTOVOZ Mykola
7	BUL	PILIKYAN NURAN Kapriel

REPECHAGE

REPECHAGE FINALISTE 1

2	3			P1 P2 P3		
	2	HUN		1	1	0
1	0			P1 P2 P3		
	0	IRI		0	0	0

2 BUBORI Antal (HUN)

Médaille de Bronze

REPECHAGE FINALISTE 2

4	3			P1 P2 P3		
	2	SRB		0	1	1
7	1			P1 P2 P3		
	1	UKR		1	0	0

4 RIZVANOVIC Senad (SRB)

Médaille de Bronze



Classement

VETERAN GR WRESTLING WCH - DIVISION "B"



STYLE : GR 63 kg

1 - Or / Gold



MARGIC Stjepan

2 - Argent / Silver



CHISTYAKOV Alexey

3 - Bronze



BUBORI Antal



RIZVANOVIC Senad

<i>Classement</i>	<i>Nom - Name</i>	<i>Pays - Country</i>
1	MARGIC Stjepan	CRO
2	CHISTYAKOV Alexey	RUS
3	BUBORI Antal	HUN
3	RIZVANOVIC Senad	SRB
5	MOHAMMADI K.M. Reza	IRI
5	ZHYTOVOZ Mykola	UKR
7	PILIKYAN NURAN K.	BUL



Feuille de compétition / Competition Sheet

VETERAN GR WRESTLING WCH - DIVISION "B"



STYLE : GR 69 kg

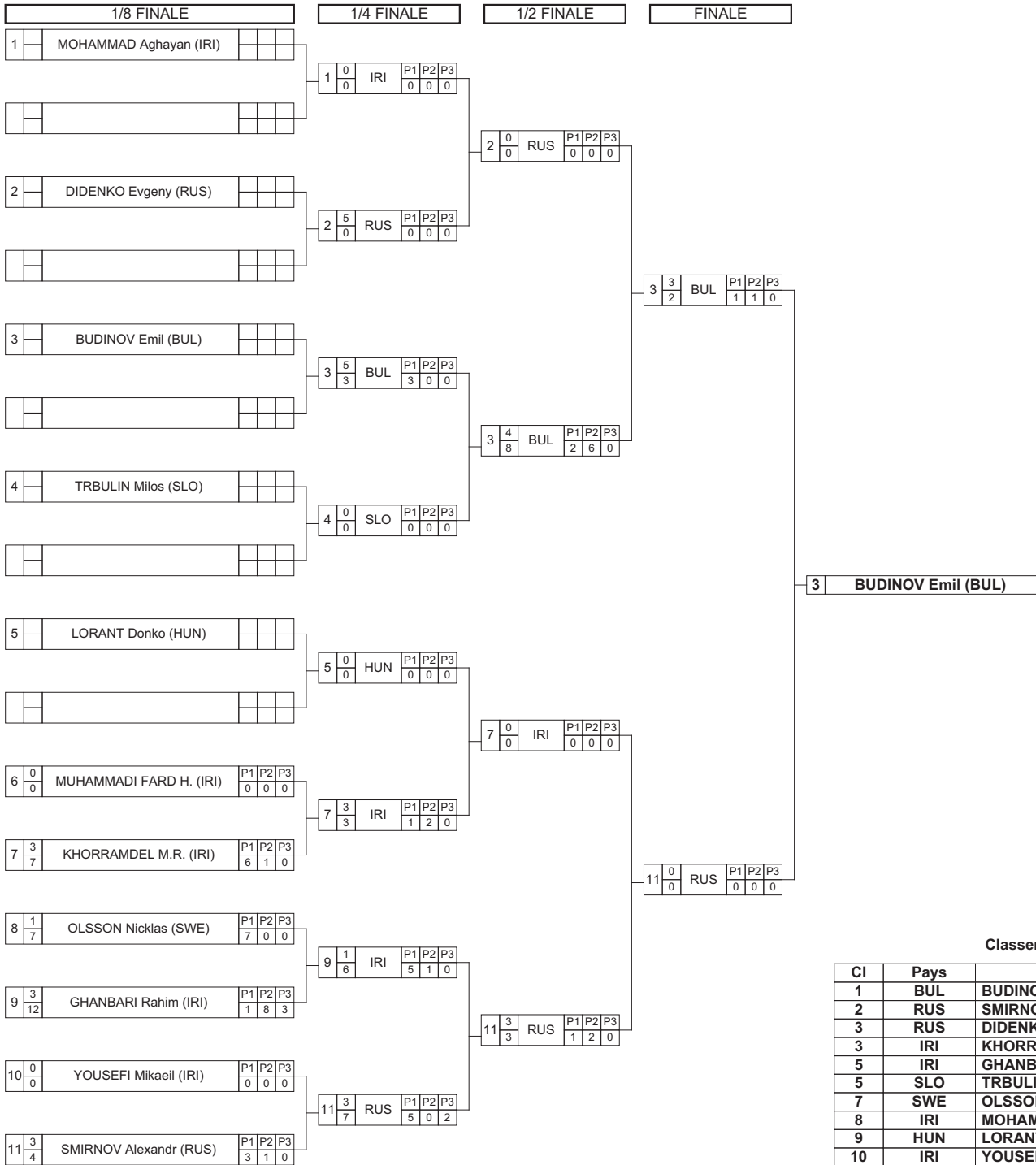

Classement

Cl	Pays	Nom
1	BUL	BUDINOV Emil
2	RUS	SMIRNOV Alexandr
3	RUS	DIDENKO Evgeny
3	IRI	KHORRAMDEL M.R.
5	IRI	GHANBARI Rahim
5	SLO	TRBULIN Milos
7	SWE	OLSSON Nicklas
8	IRI	MOHAMMAD Aghayan
9	HUN	LORANT Donko
10	IRI	YOUSEFI Mikaeil
11	IRI	MUHAMMADI FARD Hadi

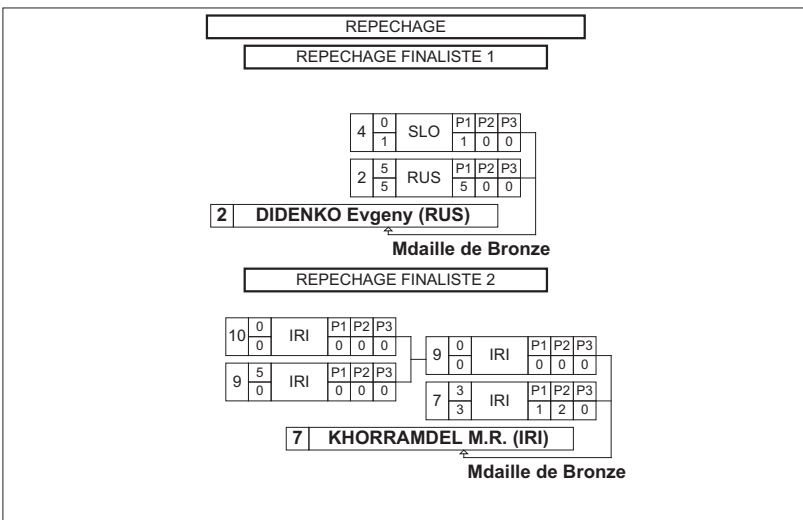



Classement

VETERAN GR WRESTLING WCH - DIVISION "B"

STYLE : GR 69 kg



1 - Or / Gold



BUDINOV Emil

2 - Argent / Silver



SMIRNOV Alexandr

3 - Bronze



DIDENKO Evgeny



KHORRAMDEL M.R.

Classement	Nom - Name	Pays - Country
1	BUDINOV Emil	BUL
2	SMIRNOV Alexandr	RUS
3	DIDENKO Evgeny	RUS
3	KHORRAMDEL M.R.	IRI
5	GHANBARI Rahim	IRI
5	TRBULIN Milos	SLO
7	OLSSON Nicklas	SWE
8	MOHAMMAD Aghayan	IRI
9	LORANT Donko	HUN
10	YOUSEFI Mikaeil	IRI
11	MUHAMMADI FARD Hadi	IRI



Feuille de compétition / Competition Sheet

VETERAN GR WRESTLING WCH - DIVISION "B"



STYLE : GR 76 kg



Classement

Cl	Pays	Nom
1	SWE	SJOEGVIST Roger
2	TUR	AMILDIZ Ercan
3	ITA	MOLFINO Jonathan
3	IRI	DEHBOZORGE R.
5	IRI	SADEGHI Assadollah
5	EST	JEVSEJEV Andrei
7	FIN	SAARI Jukka
8	FRA	FRIDIRIK Paul
9	IRI	HOSHANG SOLIMANI Amir
10	NOR	JOHANNESSEN Andre
11	GER	DEMMLER Marcus

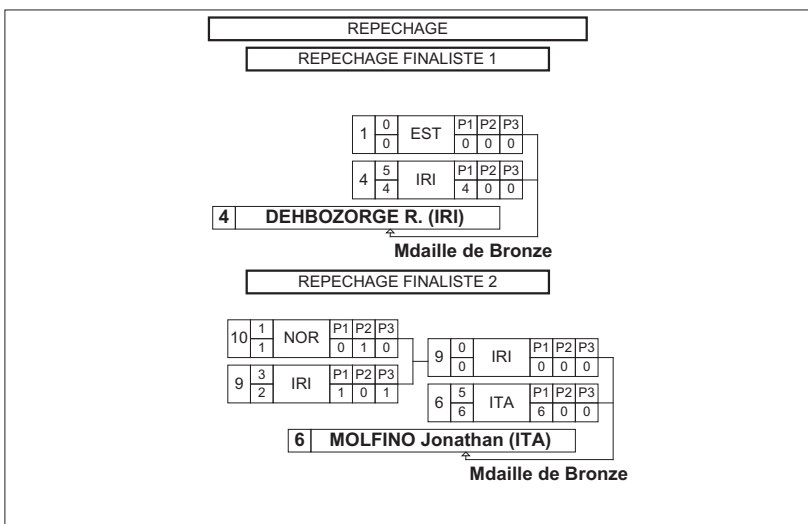



Classement

VETERAN GR WRESTLING WCH - DIVISION "B"

STYLE : GR 76 kg



1 - Or / Gold



SJOEGVIST Roger

2 - Argent / Silver



AMILDIZ Ercan

3 - Bronze



MOLFINO Jonathan



DEHBOZORGE R.

Classement	Nom - Name	Pays - Country
1	SJOEGVIST Roger	SWE
2	AMILDIZ Ercan	TUR
3	MOLFINO Jonathan	ITA
3	DEHBOZORGE R.	IRI
5	SADEGHI Assadollah	IRI
5	JEVSEJEV Andrei	EST
7	SAARI Jukka	FIN
8	FRIDIRIK Paul	FRA
9	HOSHANG SOLIMANI A.	IRI
10	JOHANNESSEN Andre	NOR
11	DEMMLER Marcus	GER



Feuille de compétition / Competition Sheet

VETERAN GR WRESTLING WCH - DIVISION "B"



STYLE : GR 85 kg



Classement

Cl	Pays	Nom
1	NOR	ANDERSEN Roy B.
2	RUS	OCHIGAVA Kobar
3	RUS	DENISOV Pavel
3	RUS	SERGEEV Alexandr
5	NOR	DALSBOTTEN Martin
5	GER	TEOFANIS Kyriakos
7	SRB	PRIKIDANOVIC Igor
8	IRI	SOTODEH M.B.

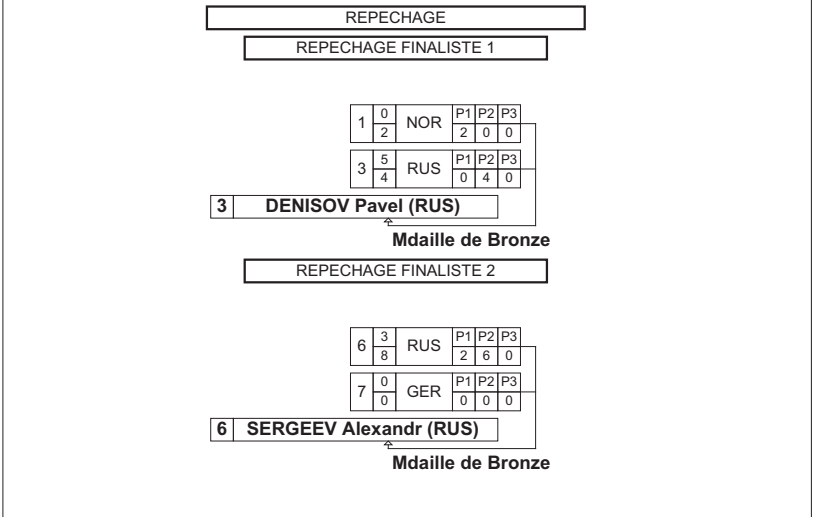



Classement

VETERAN GR WRESTLING WCH - DIVISION "B"



STYLE : GR 85 kg

1 - Or / Gold



ANDERSEN Roy B.

2 - Argent / Silver



OCHIGAVA Kobar

3 - Bronze



DENISOV Pavel



SERGEEV Alexandr

<i>Classement</i>	<i>Nom - Name</i>	<i>Pays - Country</i>
1	ANDERSEN Roy B.	NOR
2	OCHIGAVA Kobar	RUS
3	DENISOV Pavel	RUS
3	SERGEEV Alexandr	RUS
5	DALSBOTTEN Martin	NOR
5	TEOFANIS Kyriakos	GER
7	PRIKIDANOVIC Igor	SRB
8	SOTODEH M.B.	IRI



Feuille de compétition / Competition Sheet

VETERAN GR WRESTLING WCH - DIVISION "B"



STYLE : GR 97 kg



5 MEDVEDEV Boris (RUS)

Classement

Cl	Pays	Nom
1	RUS	MEDVEDEV Boris
2	UKR	OHLOBLIN Volodymyr
3	IRI	KHAJEHVAND H.
3	IRI	HEIDARZADEH Abdoljabar
5	RUS	NAGAEV Ibragim
5	IRI	AHMADZADEN Ghader
7	CRO	RABIC Sinisa
8	IRI	YOUSEF Torabi
9	FIN	KETONEN Jussi
10	USA	AYERS RONALD Sean
10	USA	JEFFERYE Anderson

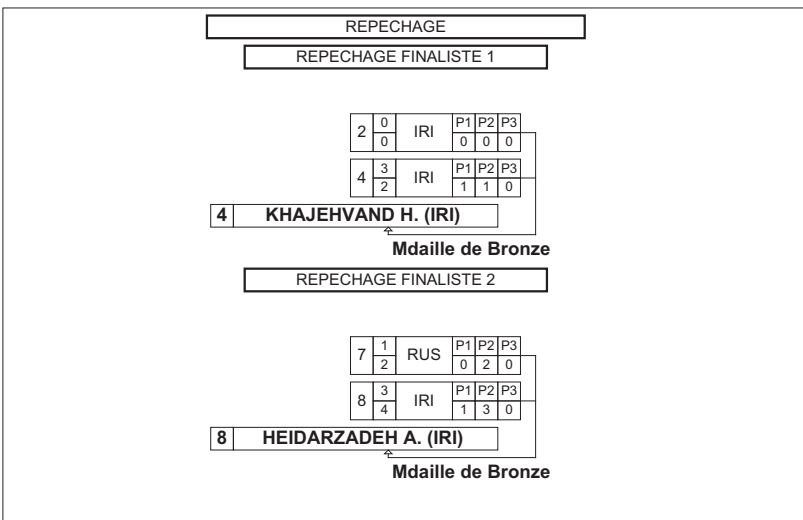



Classement

VETERAN GR WRESTLING WCH - DIVISION "B"



STYLE : GR 97 kg

1 - Or / Gold



MEDVEDEV Boris

2 - Argent / Silver



OHLOBLIN Volodymyr

3 - Bronze



KHAJEHVAND H.



HEIDARZADEH Abdoljabar

<i>Classement</i>	<i>Nom - Name</i>	<i>Pays - Country</i>
1	MEDVEDEV Boris	RUS
2	OHLOBLIN Volodymyr	UKR
3	KHAJEHVAND H.	IRI
3	HEIDARZADEH A.	IRI
5	NAGAEV Ibragim	RUS
5	AHMADZADEN Ghader	IRI
7	RABIC Sinisa	CRO
8	YOUSEF Torabi	IRI
9	KETONEN Jussi	FIN
10	AYERS RONALD Sean	USA
10	JEFFERYE Anderson	USA



Feuille de compétition / Competition Sheet

VETERAN GR WRESTLING WCH - DIVISION "B"



STYLE : GR 130 kg



Classement

Cl	Pays	Nom
1	RUS	TASHILIN Oleg
2	HUN	TURAK Pal
3	EST	USPENSKI Aap
3	TUR	AHMET Ozbege
5	IRI	ALIAKBAR Jirsareal
5	SWE	SANDBERG Stefan
7	IRI	HOSSEIN Kazemi
8	HUN	DEZSERECKI Istvan
9	TUR	BAL Erdal
10	EST	SEITON Tiit

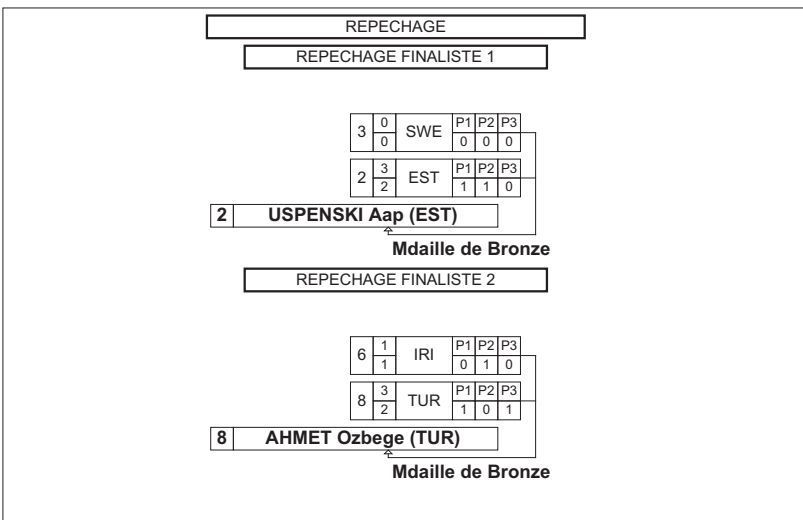



Classement

VETERAN GR WRESTLING WCH - DIVISION "B"

STYLE : GR 130 kg



1 - Or / Gold



TASHILIN Oleg

2 - Argent / Silver



TURAK Pal

3 - Bronze



USPENSKI Aap



AHMET Ozbege

Classement	Nom - Name	Pays - Country
1	TASHILIN Oleg	RUS
2	TURAK Pal	HUN
3	USPENSKI Aap	EST
3	AHMET Ozbege	TUR
5	ALIAKBAR Jirsareal	IRI
5	SANDBERG Stefan	SWE
7	HOSSEIN Kazemi	IRI
8	DEZSERECKI Istvan	HUN
9	BAL Erdal	TUR
10	SEITON Tiit	EST

**Classement par équipe / Teams ranking****VETERAN GR WRESTLING WCH - DIVISION "B"**

STYLE GR



Rang	Equipe	58 KG	63 KG	69 KG	76 KG	85 KG	97 KG	130 KG	TOTAL
1	IRI	18	6	18	14	3	25	10	94
2	RUS	8	9	17		25	16	10	85
3	BUL	22	4	10					36
4	NOR	6			1	16			23
5	HUN		8	2				12	22
6	SWE			4	10			6	20
7	TUR				9			10	19
8	EST				8			9	17
9	UKR		6				9		15
10	CRO		10				4		14
11	SRB		8			4			12
12	ITA				8				8
13	GER					6			6
14	SLO			6					6
15	FIN				4		2		6
16	FRA				3				3
17	USA						1		1

VETERAN GR WRESTLING WCH - DIVISION "C"



BELGRADE (SRB)

2010-08-14 - 2010-08-14 2010

Résultats - Results

Lutte Greco-Romaine - Greco-Roman





Liste des arbitres / Referee list

VETERAN GR WRESTLING WCH - DIVISION "C"



<i>N°</i>	<i>Licence</i>	<i>Pays Country</i>	<i>Nom - Last Name</i>	<i>Prénom - First Name</i>
-----------	----------------	-------------------------	------------------------	----------------------------





Liste des nations / Countries List

VETERAN GR WRESTLING WCH - DIVISION "C"

STYLE GR



Pays - Country

	AZERBAIJAN	AZE
	BELARUS	BLR
	BULGARIA	BUL
	DENMARK	DEN
	ESTONIA	EST
	GERMANY	GER
	HUNGARY	HUN
	IRAN R.I.	IRI
	ITALY	ITA
	KAZAKHSTAN	KAZ
	LATVIA	LAT
	LITHUANIA	LTU
	NORWAY	NOR
	POLAND	POL
	RUSSIA	RUS
	SLOVENIA	SLO
	SWEDEN	SWE
	TURKEY	TUR
	UKRAINE	UKR

Nombre de nations - Number of Countries 19

**Nombre d'engagés par nation / Number of Entries By Country****VETERAN GR WRESTLING WCH - DIVISION "C"****STYLE GR**

<i>Pays - Country</i>	<i>58 KG</i>	<i>63 KG</i>	<i>69 KG</i>	<i>76 KG</i>	<i>85 KG</i>	<i>97 KG</i>	<i>130 KG</i>	<i>TOTAL</i>
AZE	1					1		2
BLR		1						1
BUL	1	1						2
DEN				1				1
EST				1	1			2
GER	1			1		2		4
HUN			1				1	2
IRI	1	1	2	3	2	1	4	14
ITA			1	1	1			3
KAZ		1			1	1		3
LAT					1			1
LTU		1						1
NOR					1			1
POL					1			1
RUS	3	1	3	1	6	1		15
SLO						1		1
SWE			1		1			2
TUR		1						1
UKR		2					2	4
TOTAL	7	9	8	8	15	7	7	61

Nombre de nations - Number of Countries 19



Liste des Engagés par pays / Entry-List By Country

VETERAN GR WRESTLING WCH - DIVISION "C"

STYLE GR



AZERBAIJAN (AZE)

Lutteur(s) / Wrestler(s) :

58 kg	MAMMDOV, Tazidzel
97 kg	ISMAYILKHANLI, Rovsan

BELARUS (BLR)

Lutteur(s) / Wrestler(s) :

63 kg	CHEPELAU, Mikalai
-------	-------------------

BULGARIA (BUL)

Lutteur(s) / Wrestler(s) :

58 kg	BOGIN, Tachev
63 kg	STOYANOV S, Petrov

DENMARK (DEN)

Lutteur(s) / Wrestler(s) :

76 kg	ALI YAZDANI, Mohammad
-------	-----------------------

ESTONIA (EST)

Lutteur(s) / Wrestler(s) :

76 kg	LAINÉ, Tonu
85 kg	UPPIN, Endel

GERMANY (GER)

Lutteur(s) / Wrestler(s) :

58 kg	GERSCHMANN, Jakob
76 kg	HEMMANN, Uwe
97 kg	GOVEDARICA, Milos WEBER, Rainer

HUNGARY (HUN)

Lutteur(s) / Wrestler(s) :

69 kg	PALI, Sandor
130 kg	FOLDESI, Istvan



Liste des Engagés par pays / Entry-List By Country

VETERAN GR WRESTLING WCH - DIVISION "C"

STYLE GR



IRAN R.I. (IRI)

Lutteur(s) / Wrestler(s) :

58 kg	KAKAHAJI, K
63 kg	BASHIRI, Gholamadbass
69 kg	HOSSINI, M SALEHPOUR, Askari
76 kg	ALMASI, Hormoz EBRAHIMI, M SEIFKHANI, S
85 kg	ESFANDIYARI, Bahamu GHOLAMREZA, Mohammadi
97 kg	BOH LOUU, Khosrow
130 kg	AFRASHTEN, Akbar ALIAKBAR HOSSEIN, Salari GHALEN KOHNEN, Reza MOHAMMED, Marzban

ITALY (ITA)

Lutteur(s) / Wrestler(s) :

69 kg	PICCININI, Domenico
76 kg	RASPADORI, Stefano
85 kg	CASAROLA, Maorizio

KAZAKHSTAN (KAZ)

Lutteur(s) / Wrestler(s) :

63 kg	SERGAZIJEV, Kasenhan
85 kg	ZHANPEISOV, Kadyrzhan
97 kg	ZABAKOV, Abdulla

LATVIA (LAT)

Lutteur(s) / Wrestler(s) :

85 kg	KOMANENKO, Sergejs
-------	--------------------

LITHUANIA (LTU)

Lutteur(s) / Wrestler(s) :

63 kg	KRIKSCIJNAS, Aruydas
-------	----------------------

NORWAY (NOR)



Liste des Engagés par pays / Entry-List By Country

VETERAN GR WRESTLING WCH - DIVISION "C"



STYLE GR

Lutteur(s) / Wrestler(s) :

85 kg MORTEN, Hageld

POLAND (POL)

Lutteur(s) / Wrestler(s) :

85 kg BLAUTENBERG, Laslek

RUSSIA (RUS)

Lutteur(s) / Wrestler(s) :

58 kg CHUEV, Igor
RAKHMANGULOV, Rami
ZABAIROV, Radik

63 kg ZANGIROV, Dmitriy

69 kg ALEXANDER, Popov
SAVIN, Andrey
SHARAFUTDINOV, Gusman

76 kg IVANCHENKO, Valeri

85 kg GENNADIY, Ovdin
GOREV, Mikhail
JANKOVSKI, Serguel
KANTORSHIKOV, Yuri
SEMANOV, Andrey
SHAFIEV, Fatikh

97 kg DYUKOV, Yuri

SLOVENIA (SLO)

Lutteur(s) / Wrestler(s) :

97 kg HORVAT, Milos

SWEDEN (SWE)

Lutteur(s) / Wrestler(s) :

69 kg HAZBULAT, Gazdiev

85 kg MOLIN, Thomas

TURKEY (TUR)

Lutteur(s) / Wrestler(s) :

63 kg MEHMET BEKTAS, Kenan



Liste des Engagés par pays / Entry-List By Country

VETERAN GR WRESTLING WCH - DIVISION "C"

STYLE GR



UKRAINE (UKR)

Lutteur(s) / Wrestler(s) :

63 kg

NYLYPYUK, Mykhaylo
PAVLYUK, Anatoliy

130 kg

ABRAMOVSKYY, Artur
VORONIN, Lev



Feuille de compétition / Competition Sheet

VETERAN GR WRESTLING WCH - DIVISION "C"



STYLE : GR 58 kg



Classement

Cl	Pays	Nom
1	RUS	CHUEV Igor
2	AZE	MAMMDOV Tazidzel
3	RUS	ZABAIROV Radik
3	RUS	RAKHMANGULOV Rami
5	BUL	BOGIN Tachev
6	IRI	KAKAHAJI K
7	GER	GERSCHMANN Jakob

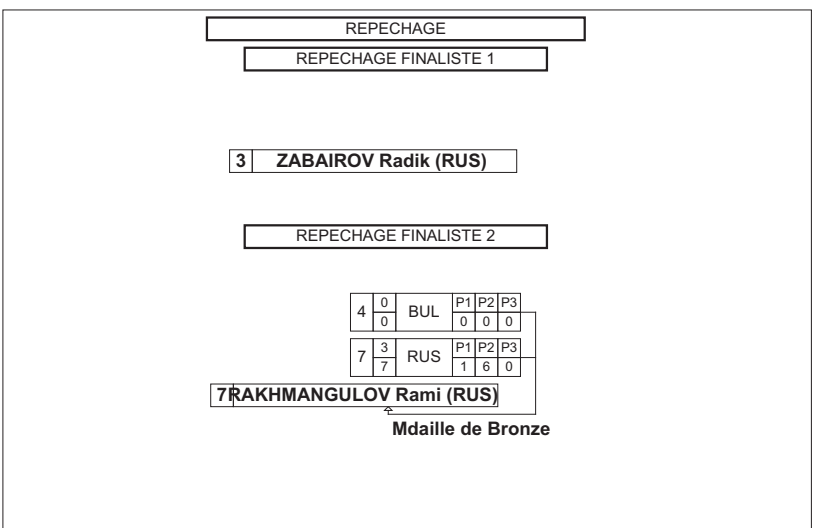



Classement

VETERAN GR WRESTLING WCH - DIVISION "C"



STYLE : GR 58 kg

1 - Or / Gold



CHUEV Igor

2 - Argent / Silver



MAMMDOV Tazidzel

3 - Bronze



ZABAIROV Radik



RAKHMANGULOV Rami

<i>Classement</i>	<i>Nom - Name</i>	<i>Pays - Country</i>
1	CHUEV Igor	RUS
2	MAMMDOV Tazidzel	AZE
3	ZABAIROV Radik	RUS
3	RAKHMANGULOV Rami	RUS
5	BOGIN Tachev	BUL
6	KAKAHAJI K	IRI
7	GERSCHMANN Jakob	GER



Feuille de compétition / Competition Sheet

VETERAN GR WRESTLING WCH - DIVISION "C"



STYLE : GR 63 kg

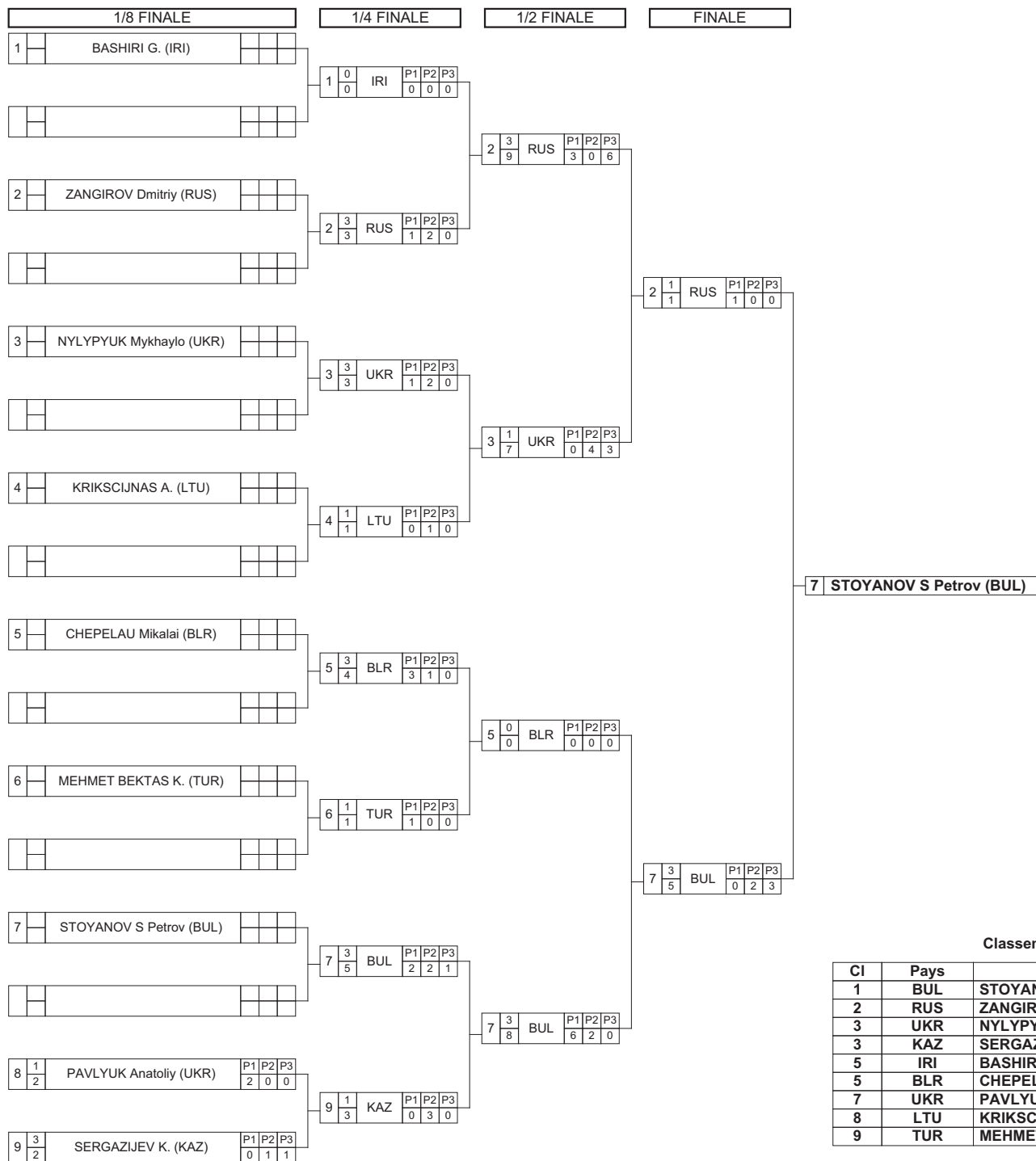

Classement

Cl	Pays	Nom
1	BUL	STOYANOV S Petrov
2	RUS	ZANGIROV Dmitriy
3	UKR	NYLYPYUK Mykhaylo
3	KAZ	SERGAZIJEV Kasenhan
5	IRI	BASHIRI Gholamadbas
5	BLR	CHEPELAU Mikalai
7	UKR	PAVLYUK Anatoliy
8	LTU	KRIKSCIJNAS Aruydas
9	TUR	MEHMET BEKTAS Kenan

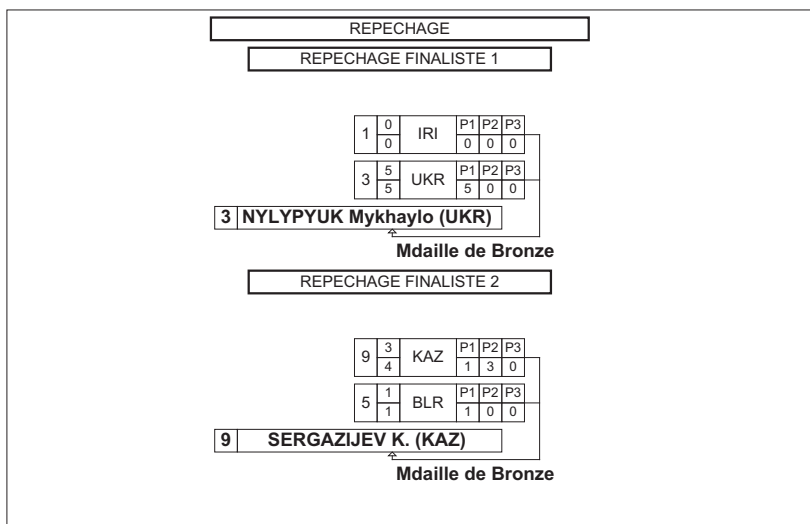



Classement

VETERAN GR WRESTLING WCH - DIVISION "C"



STYLE : GR 63 kg

1 - Or / Gold



STOYANOV S Petrov

2 - Argent / Silver



ZANGIROV Dmitriy

3 - Bronze



NYLYPYUK Mykhaylo



SERGAZIJEV Kasenhan

Classement	Nom - Name	Pays - Country
1	STOYANOV S Petrov	BUL
2	ZANGIROV Dmitriy	RUS
3	NYLYPYUK Mykhaylo	UKR
3	SERGAZIJEV Kasenhan	KAZ
5	BASHIRI Gholamadbas	IRI
5	CHEPELAU Mikalai	BLR
7	PAVLYUK Anatoliy	UKR
8	KRIKSCIJNAS Aruydas	LTU
9	MEHMET BEKTAS Kenan	TUR



Feuille de compétition / Competition Sheet

VETERAN GR WRESTLING WCH - DIVISION "C"



STYLE : GR 69 kg



Classement

Cl	Pays	Nom
1	SWE	HAZBULAT Gazdiev
2	ITA	PICCININI Domenico
3	IRI	SALEHPOUR Askari
3	IRI	HOSSINI M
5	HUN	PALI Sandor
5	RUS	SHARAFUTDINOV Gusman
7	RUS	SAVIN Andrey
8	RUS	ALEXANDER Popov

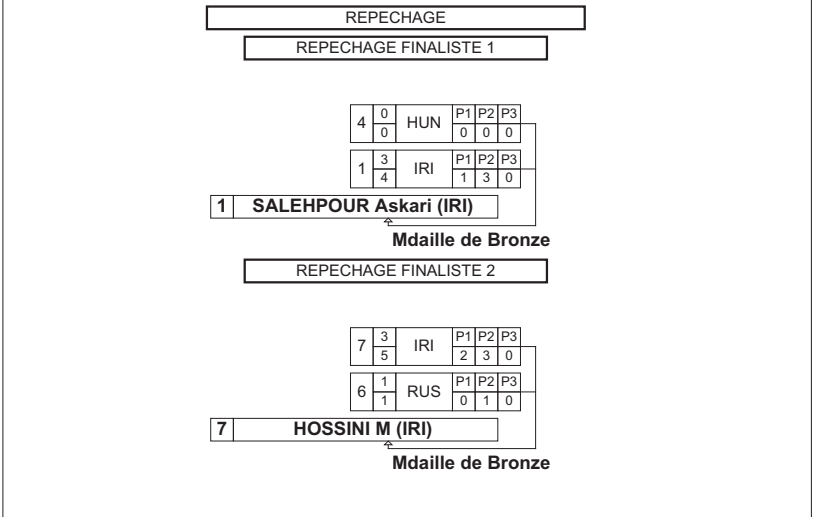



Classement

VETERAN GR WRESTLING WCH - DIVISION "C"

STYLE : GR 69 kg



1 - Or / Gold



HAZBULAT Gazdiev

2 - Argent / Silver



PICCININI Domenico

3 - Bronze



SALEHPOUR Askari



HOSSINI M

Classement	Nom - Name	Pays - Country
1	HAZBULAT Gazdiev	SWE
2	PICCININI Domenico	ITA
3	SALEHPOUR Askari	IRI
3	HOSSINI M	IRI
5	PALI Sandor	HUN
5	SHARAFUTDINOV G.	RUS
7	SAVIN Andrey	RUS
8	ALEXANDER Popov	RUS



Feuille de compétition / Competition Sheet

VETERAN GR WRESTLING WCH - DIVISION "C"



STYLE : GR 76 kg



Classement

Cl	Pays	Nom
1	IRI	SEIFKHANI S
2	DEN	ALI YAZDANI Mohammad
3	GER	HEMMANN Uwe
3	IRI	EBRAHIMI M
5	RUS	IVANCHENKO Valeri
5	EST	LAINE Tonu
7	IRI	ALMASI Hormoz
8	ITA	RASPADORI Stefano

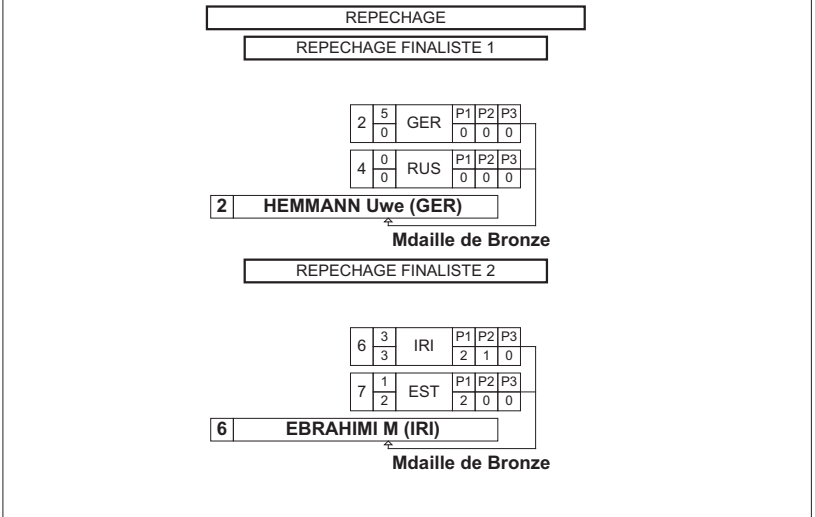



Classement

VETERAN GR WRESTLING WCH - DIVISION "C"

STYLE : GR 76 kg



1 - Or / Gold



SEIFKHANI S

2 - Argent / Silver



ALI YAZDANI Mohammad

3 - Bronze



HEMMANN Uwe



EBRAHIMI M

Classement	Nom - Name	Pays - Country
1	SEIFKHANI S	IRI
2	ALI YAZDANI M.	DEN
3	HEMMANN Uwe	GER
3	EBRAHIMI M	IRI
5	IVANCHENKO Valeri	RUS
5	LAINÉ TONU	EST
7	ALMASI Hormoz	IRI
8	RASPADORI Stefano	ITA



Feuille de compétition / Competition Sheet

VETERAN GR WRESTLING WCH - DIVISION "C"



STYLE : GR 85 kg

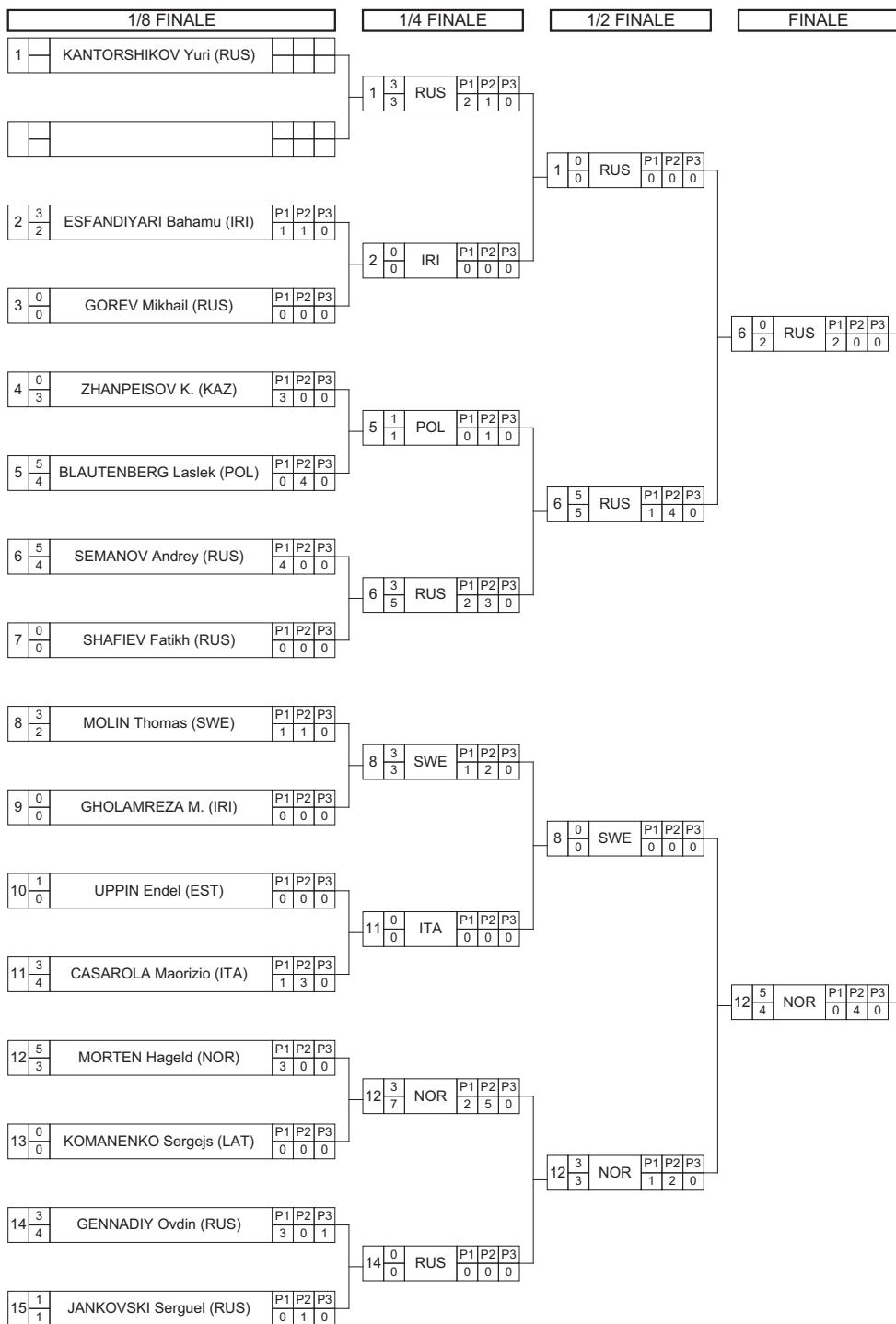

12 MORTEN Hageld (NOR)

Classement

Cl	Pays	Nom
1	NOR	MORTEN Hageld
2	RUS	SEMANOV Andrey
3	RUS	KANTORSHIKOV Yuri
3	SWE	MOLIN Thomas
5	POL	BLAUTENBERG Laslek
5	RUS	GENNADIY Ovdin
7	ITA	CASAROLA Maorizio
8	IRI	ESFANDIYARI Bahamu
9	RUS	JANKOVSKI Serguel
10	EST	UPPIN Endel
11	KAZ	ZHANPEISOV Kadyrzhan
12	RUS	GOREV Mikhail
12	IRI	GHOLAMREZA Mohammadi
14	LAT	KOMANENKO Sergejs
15	RUS	SHAFIEV Fatikh

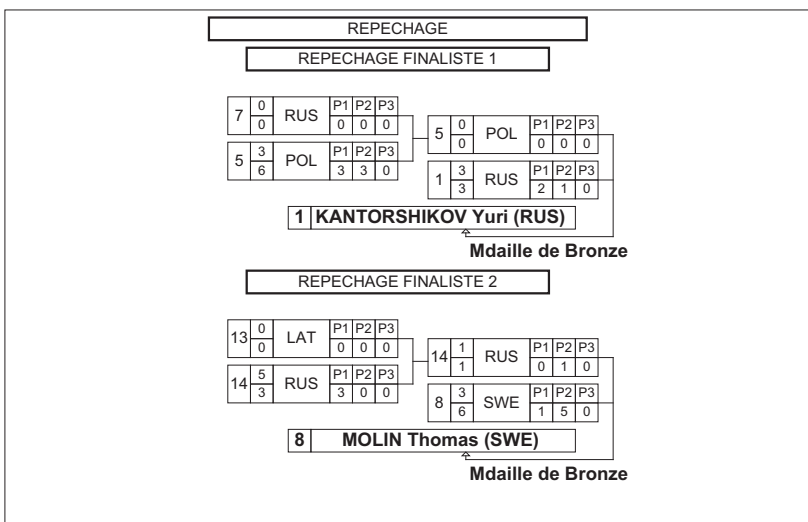



Classement

VETERAN GR WRESTLING WCH - DIVISION "C"

STYLE : GR 85 kg



1 - Or / Gold



MORTEN Hageld

2 - Argent / Silver



SEMANOV Andrey

3 - Bronze



KANTORSHIKOV Yuri



MOLIN Thomas

Classement	Nom - Name	Pays - Country
1	MORTEN Hageld	NOR
2	SEMANOV Andrey	RUS
3	KANTORSHIKOV Yuri	RUS
3	MOLIN Thomas	SWE
5	BLAUTENBERG Laslek	POL
5	GENNADIY Ovdin	RUS
7	CASAROLA Maorizio	ITA
8	ESFANDIYARI Bahamu	IRI
9	JANKOVSKI Serguel	RUS
10	UPPIN Endel	EST
11	ZHANPEISOV K.	KAZ
12	GOREV Mikhail	RUS
12	GHOLAMREZA M.	IRI
14	KOMANENKO Sergejs	LAT
15	SHAFIEV Fatikh	RUS



Feuille de compétition / Competition Sheet

VETERAN GR WRESTLING WCH - DIVISION "C"



STYLE : GR 97 kg

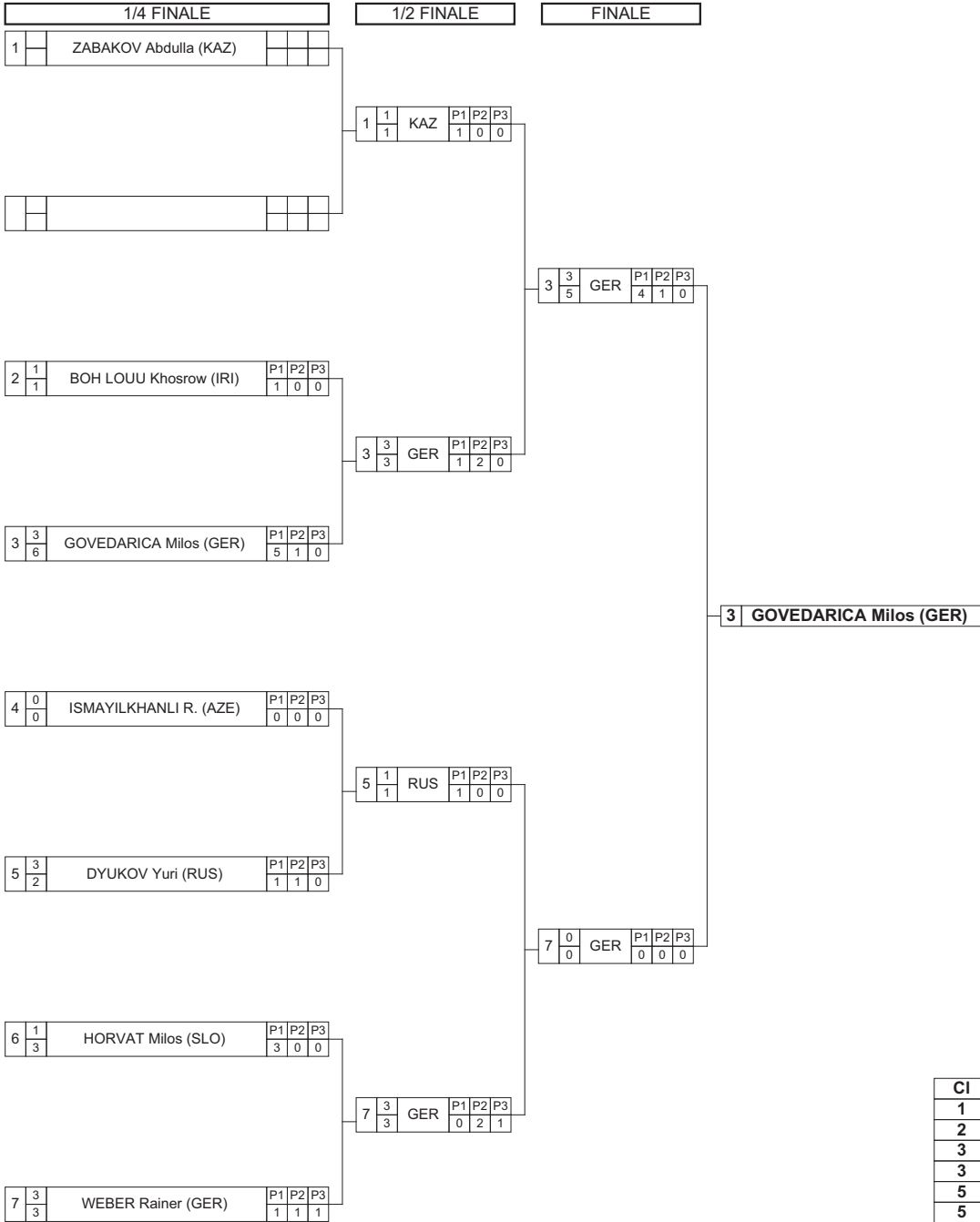

Classement

Cl	Pays	Nom
1	GER	GOVEDARICA Milos
2	GER	WEBER Rainer
3	IRI	BOH LOUU Khosrow
3	RUS	DYUKOV Yuri
5	KAZ	ZABAKOV Abdulla
5	SLO	HORVAT Milos
7	AZE	ISMAYILKHANLI Rovsan

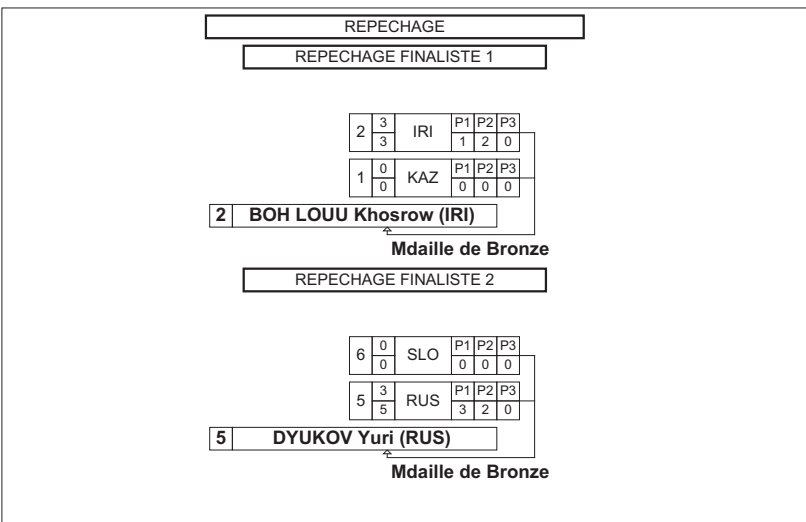



Classement

VETERAN GR WRESTLING WCH - DIVISION "C"



STYLE : GR 97 kg

1 - Or / Gold



GOVEDARICA Milos

2 - Argent / Silver



WEBER Rainer

3 - Bronze



BOH LOUU Khosrow



DYUKOV Yuri

<i>Classement</i>	<i>Nom - Name</i>	<i>Pays - Country</i>
1	GOVEDARICA Milos	GER
2	WEBER Rainer	GER
3	BOH LOUU Khosrow	IRI
3	DYUKOV Yuri	RUS
5	ZABAKOV Abdulla	KAZ
5	HORVAT Milos	SLO
7	ISMAYILKHANLI R.	AZE



Classement

VETERAN GR WRESTLING WCH - DIVISION "C"

STYLE : GR 130 kg



1 - Or / Gold



VORONIN Lev

2 - Argent / Silver



AFRASHTEN Akbar

3 - Bronze



MOHAMMED Marzban



FOLDESI Istvan

Classement	Nom - Name	Pays - Country
1	VORONIN Lev	UKR
2	AFRASHTEN Akbar	IRI
3	MOHAMMED Marzban	IRI
3	FOLDESI Istvan	HUN
5	ABRAMOVSKYY Artur	UKR
5	GHALEN KOHNEN Reza	IRI
7	ALIAKBAR HOSSEIN S.	IRI

VETERAN GR WRESTLING WCH - DIVISION "D"



BELGRADE (SRB)

2010-08-14 - 2010-08-14 2010

Résultats - Results

Lutte Greco-Romaine - Greco-Roman





Liste des arbitres / Referee list

VETERAN GR WRESTLING WCH - DIVISION "D"



<i>N°</i>	<i>Licence</i>	<i>Pays Country</i>	<i>Nom - Last Name</i>	<i>Prénom - First Name</i>
-----------	----------------	-------------------------	------------------------	----------------------------





Liste des nations / Countries List

VETERAN GR WRESTLING WCH - DIVISION "D"

STYLE GR



Pays - Country

	ARGENTINA	ARG
	AZERBAIJAN	AZE
	BULGARIA	BUL
	GERMANY	GER
	GREECE	GRE
	HUNGARY	HUN
	IRAN R.I.	IRI
	KAZAKHSTAN	KAZ
	LITHUANIA	LTU
	POLAND	POL
	RUSSIA	RUS
	SERBIA	SRB
	SWEDEN	SWE
	TURKEY	TUR
	UKRAINE	UKR
	UNITED STATES	USA

Nombre de nations - Number of Countries 16

**Nombre d'engagés par nation / Number of Entries By Country****VETERAN GR WRESTLING WCH - DIVISION "D"****STYLE GR**

<i>Pays - Country</i>	<i>58 KG</i>	<i>63 KG</i>	<i>69 KG</i>	<i>76 KG</i>	<i>85 KG</i>	<i>97 KG</i>	<i>130 KG</i>	<i>TOTAL</i>
ARG				1				1
AZE				1	1			2
BUL	1		1	1				3
GER	1			1	1			3
GRE					1			1
HUN				1		1		2
IRI	1	4		1		2	1	9
KAZ			1					1
LTU			1					1
POL			1		1	1		3
RUS	1	3	2	2	2	1	1	12
SRB					1			1
SWE			1	1				2
TUR	1							1
UKR				1			1	2
USA			1	1				2
TOTAL	5	7	8	11	7	5	3	46

Nombre de nations - Number of Countries 16



Liste des Engagés par pays / Entry-List By Country

VETERAN GR WRESTLING WCH - DIVISION "D"

STYLE GR



ARGENTINA (ARG)

Lutteur(s) / Wrestler(s) :

76 kg RODRIGUEZ, Daniel

AZERBAIJAN (AZE)

Lutteur(s) / Wrestler(s) :

76 kg ALIABBASOV, Alisaxab
85 kg ALISMANOV, Shakarhan

BULGARIA (BUL)

Lutteur(s) / Wrestler(s) :

58 kg NIKOLAY BORISOV, Vidov
69 kg HRISTOV, Georgi
76 kg RANGELOV, Ivan

GERMANY (GER)

Lutteur(s) / Wrestler(s) :

58 kg JURGEN, Hub
76 kg MULLER RAINER, Jorg
85 kg SCHROEDER, Wilhelm

GREECE (GRE)

Lutteur(s) / Wrestler(s) :

85 kg KONSTANTINOS, Traskas

HUNGARY (HUN)

Lutteur(s) / Wrestler(s) :

76 kg HENCY, Gyula
97 kg GALAMBOS, Ferenc

IRAN R.I. (IRI)

Lutteur(s) / Wrestler(s) :

58 kg HATAMI, A
63 kg FATAHI, K



Liste des Engagés par pays / Entry-List By Country

VETERAN GR WRESTLING WCH - DIVISION "D"



STYLE GR

	MOHAMMAD TAGHI, Bolandpour
	RAJABI, E
	SAYED HOSSEIN, Mousavisaein
76 kg	BAHRAMI, S
97 kg	ALINEJAD, A
	NOURBAKHSK, Auasgh
130 kg	GHADERI, Jamshid

KAZAKHSTAN (KAZ)

Lutteur(s) / Wrestler(s) :

69 kg	DERBISSALIYEV, Tungishbay
-------	---------------------------

LITHUANIA (LTU)

Lutteur(s) / Wrestler(s) :

69 kg	ILKEVICIUS, Nikolajus
-------	-----------------------

POLAND (POL)

Lutteur(s) / Wrestler(s) :

69 kg	ZBIGNIEW, Krasoski
85 kg	BRZOZOWSKI, Zdzislaw
97 kg	WIECZORKIEWICZ, Miroslav

RUSSIA (RUS)

Lutteur(s) / Wrestler(s) :

58 kg	PROKOPIEV, Michail
63 kg	KHAMIDULLIN, Radik
	KHAMIDULLIN, Rafik
	ZYUKOV, Vladimir
69 kg	KOLMYKOV, Nikolay
	SHAYDULLIN, Ilgiz
76 kg	KUKUSHKIN, Viktor
	SARGACHEV, Alexandr
85 kg	KARAMATOV, Nabi
	KAZAKOV, Nikolay
97 kg	ABDRASHITOV, Safuulloov
130 kg	PISAKIN, Alexander

SERBIA (SRB)



Liste des Engagés par pays / Entry-List By Country

VETERAN GR WRESTLING WCH - DIVISION "D"

STYLE GR



Lutteur(s) / Wrestler(s) :

85 kg

STOJIC, Vlaho

SWEDEN (SWE)

Lutteur(s) / Wrestler(s) :

69 kg

UNNLINDAHL, Hans

76 kg

JOHANSSON, Ulf

TURKEY (TUR)

Lutteur(s) / Wrestler(s) :

58 kg

ILHIDIV, Senlik

UKRAINE (UKR)

Lutteur(s) / Wrestler(s) :

76 kg

ADYRKHAIEV, Soslan

130 kg

SHAKIN, Anatoly

UNITED STATES (USA)

Lutteur(s) / Wrestler(s) :

69 kg

VALENTIN, Kalika

76 kg

BROWN, Chris



Feuille de compétition / Competition Sheet

VETERAN GR WRESTLING WCH - DIVISION "D"

STYLE : GR 58 kg



TOUR : 1

1	4 12	NIKOLAY BORISOV V. (BUL)	P1 6	P2 6	P3 0	1	NIKOLAY BORISOV V. (BUL)
2	0 0	HATAMI A (IRI)	P1 0	P2 0	P3 0		
3	3 4	PROKOPIEV Michail (RUS)	P1 3	P2 1	P3 0	3	PROKOPIEV Michail (RUS)
4	0 0	JURGEN Hub (GER)	P1 0	P2 0	P3 0		

TOUR : 2

5	0 0	ILHIDIV Senlik (TUR)	P1 0	P2 0	P3 0	1	NIKOLAY BORISOV V. (BUL)
1	4 7	NIKOLAY BORISOV V. (BUL)	P1 7	P2 0	P3 0		
2	1 2	HATAMI A (IRI)	P1 2	P2 0	P3 0	3	PROKOPIEV Michail (RUS)
3	3 6	PROKOPIEV Michail (RUS)	P1 3	P2 3	P3 0		

TOUR : 3

4	1 4	JURGEN Hub (GER)	P1 0	P2 4	P3 0	1	NIKOLAY BORISOV V. (BUL)
1	3 8	NIKOLAY BORISOV V. (BUL)	P1 2	P2 6	P3 0		
5	3 3	ILHIDIV Senlik (TUR)	P1 0	P2 2	P3 1	5	ILHIDIV Senlik (TUR)
2	1 3	HATAMI A (IRI)	P1 2	P2 0	P3 1		

TOUR : 4

3	1 7	PROKOPIEV Michail (RUS)	P1 0	P2 7	P3 0	1	NIKOLAY BORISOV V. (BUL)
1	3 12	NIKOLAY BORISOV V. (BUL)	P1 7	P2 3	P3 2		
4	3 5	JURGEN Hub (GER)	P1 4	P2 1	P3 0	4	JURGEN Hub (GER)
5	0 0	ILHIDIV Senlik (TUR)	P1 0	P2 0	P3 0		

TOUR : 5

2	0 0	HATAMI A (IRI)	P1 0	P2 0	P3 0	4	JURGEN Hub (GER)
4	4 0	JURGEN Hub (GER)	P1 0	P2 0	P3 0		
3	4 2	PROKOPIEV Michail (RUS)	P1 2	P2 0	P3 0	3	PROKOPIEV Michail (RUS)
5	0 0	ILHIDIV Senlik (TUR)	P1 0	P2 0	P3 0		

Classement

Cl	Pays	Nom	Points
1	BUL	NIKOLAY BORISOV V.	14
2	RUS	PROKOPIEV Michail	11
3	GER	JURGEN Hub	8
4	TUR	ILHIDIV Senlik	3
5	IRI	HATAMI A	2



Classement

VETERAN GR WRESTLING WCH - DIVISION "D"



STYLE : GR 58 kg

1 - Or / Gold



NIKOLAY BORISOV Vidov

2 - Argent / Silver



PROKOPIEV Michail

3 - Bronze



JURGEN Hub

<i>Classement</i>	<i>Nom - Name</i>	<i>Pays - Country</i>	<i>Points</i>
1	NIKOLAY BORISOV V.	BUL	14
2	PROKOPIEV Michail	RUS	11
3	JURGEN Hub	GER	8
4	ILHIDIV Senlik	TUR	3
5	HATAMI A	IRI	2



Feuille de compétition / Competition Sheet

VETERAN GR WRESTLING WCH - DIVISION "D"



STYLE : GR 63 kg



Classement

Cl	Pays	Nom
1	IRI	RAJABI E
2	RUS	KHAMIDULLIN Rafik
3	RUS	ZYUKOV Vladimir
3	IRI	FATAHI K
5	IRI	MOHAMMAD TAGHI Bolandpour
6	IRI	SAYED HOSSEIN Mousavisaein
7	RUS	KHAMIDULLIN Radik

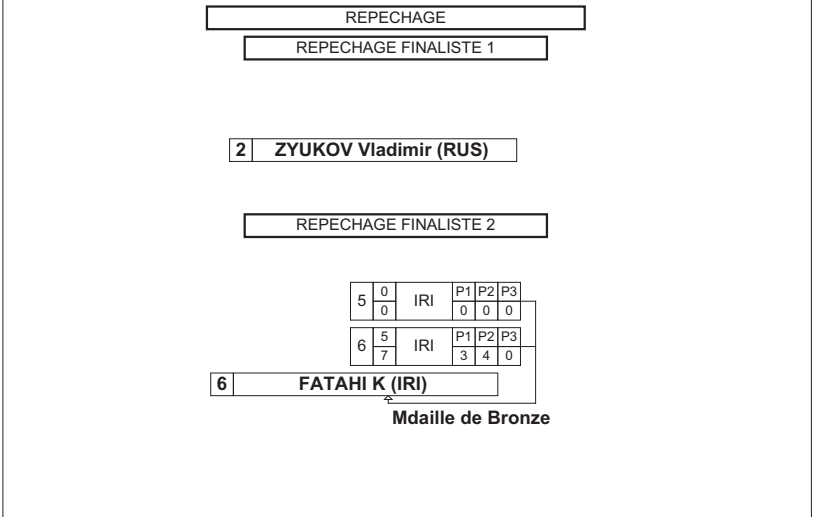



Classement

VETERAN GR WRESTLING WCH - DIVISION "D"



STYLE : GR 63 kg

1 - Or / Gold



RAJABI E

2 - Argent / Silver



KHAMIDULLIN Rafik

3 - Bronze



ZYUKOV Vladimir



FATAHI K

Classement	Nom - Name	Pays - Country
1	RAJABI E	IRI
2	KHAMIDULLIN Rafik	RUS
3	ZYUKOV Vladimir	RUS
3	FATAHI K	IRI
5	MOHAMMAD TAGHI B.	IRI
6	SAYED HOSSEIN M.	IRI
7	KHAMIDULLIN Radik	RUS



Feuille de compétition / Competition Sheet

VETERAN GR WRESTLING WCH - DIVISION "D"



STYLE : GR 69 kg



Classement

Cl	Pays	Nom
1	BUL	HRISTOV Georgi
2	POL	ZBIGNIEW Krasoski
3	KAZ	DERBISSALIYEV Tungishbay
3	SWE	UNNLINDAHL Hans
5	RUS	KOLMYKOV Nikolay
5	USA	VALENTIN Kalika
7	LTU	ILKEVICIUS Nikolajus
8	RUS	SHAYDULLIN Ilgiz

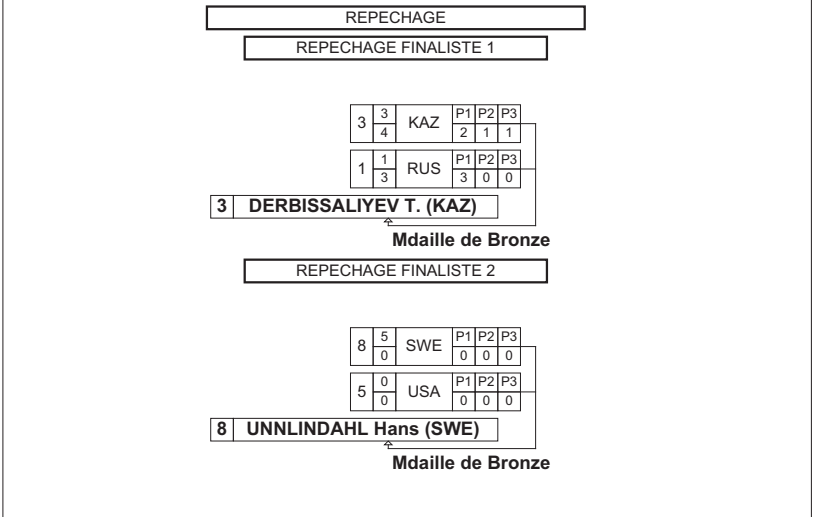



Classement

VETERAN GR WRESTLING WCH - DIVISION "D"



STYLE : GR 69 kg

1 - Or / Gold



HRISTOV Georgi

2 - Argent / Silver



ZBIGNIEW Krasoski

3 - Bronze



DERBISSALIYEV Tungishbay



UNNLINDAHL Hans

<i>Classement</i>	<i>Nom - Name</i>	<i>Pays - Country</i>
1	HRISTOV Georgi	BUL
2	ZBIGNIEW Krasoski	POL
3	DERBISSALIYEV T.	KAZ
3	UNNLINDAHL Hans	SWE
5	KOLMYKOV Nikolay	RUS
5	VALENTIN Kalika	USA
7	ILKEVICIUS N.	LTU
8	SHAYDULLIN Ilgiz	RUS



Feuille de compétition / Competition Sheet

VETERAN GR WRESTLING WCH - DIVISION "D"



STYLE : GR 76 kg

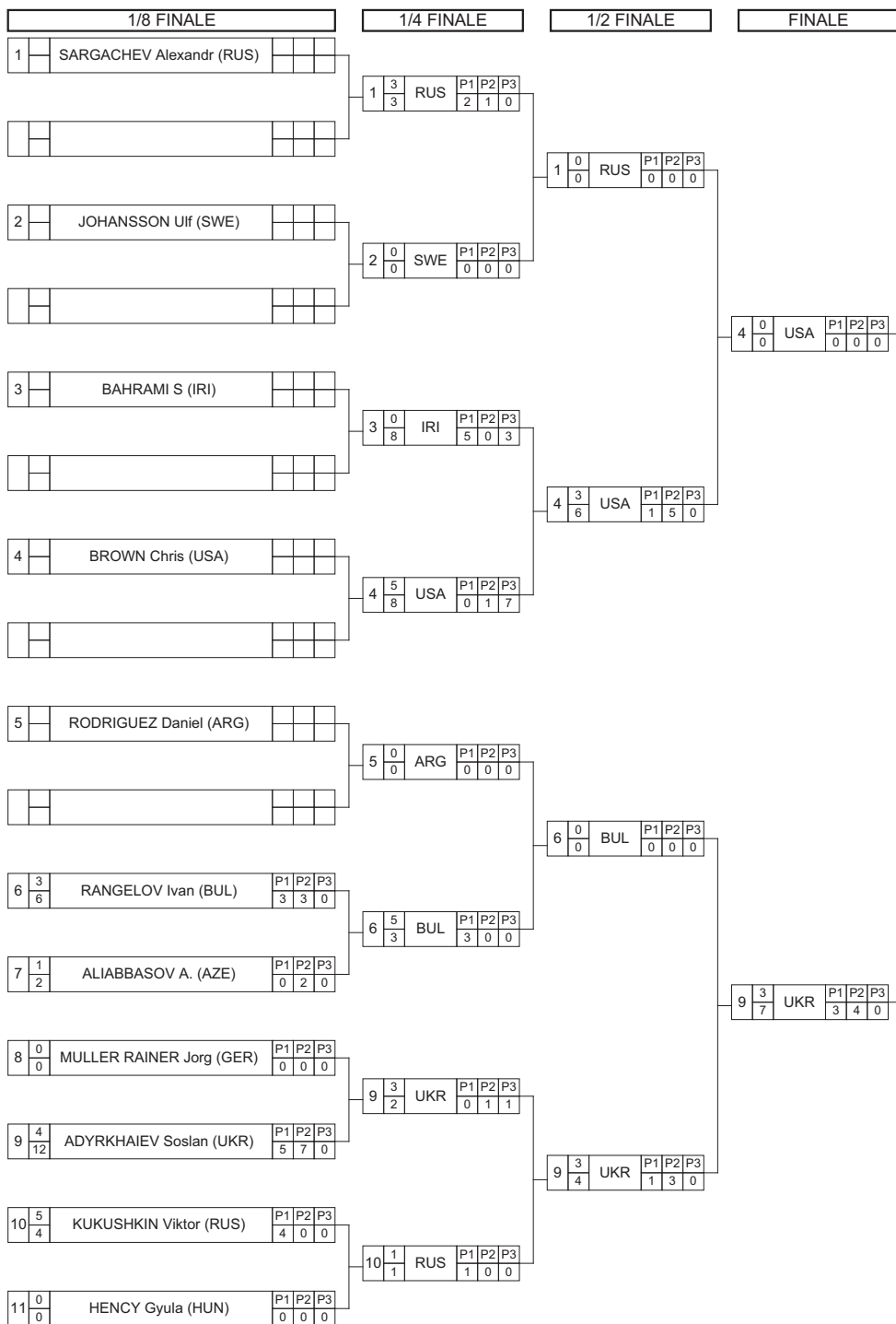

9 ADYRKHAIEV Soslan (UKR)

Classement

Cl	Pays	Nom
1	UKR	ADYRKHAIEV Soslan
2	USA	BROWN Chris
3	IRI	BAHRAMI S
3	RUS	KUKUSHKIN Viktor
5	BUL	RANGELOV Ivan
5	RUS	SARGACHEV Alexandr
7	AZE	ALIABBASOV Alisaxab
8	ARG	RODRIGUEZ Daniel
9	SWE	JOHANSSON Ulf
10	HUN	HENCY Gyula
11	GER	MULLER RAINER Jorg

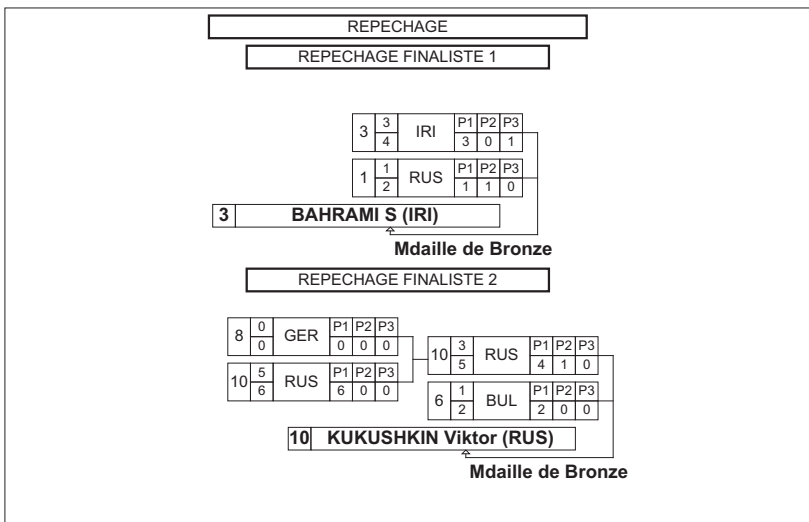



Classement

VETERAN GR WRESTLING WCH - DIVISION "D"

STYLE : GR 76 kg



1 - Or / Gold



ADYRKHAIEV Soslan

2 - Argent / Silver



BROWN Chris

3 - Bronze



BAHRAMI S



KUKUSHKIN Viktor

Classement	Nom - Name	Pays - Country
1	ADYRKHAIEV Soslan	UKR
2	BROWN Chris	USA
3	BAHRAMI S	IRI
3	KUKUSHKIN Viktor	RUS
5	RANGELOV Ivan	BUL
5	SARGACHEV Alexandr	RUS
7	ALIABBASOV Alisaxab	AZE
8	RODRIGUEZ Daniel	ARG
9	JOHANSSON Ulf	SWE
10	HENCY Gyula	HUN
11	MULLER RAINER Jorg	GER



Feuille de compétition / Competition Sheet

VETERAN GR WRESTLING WCH - DIVISION "D"



STYLE : GR 85 kg



Classement

Cl	Pays	Nom
1	RUS	KAZAKOV Nikolay
2	POL	BRZOWSKI Zdzislaw
3	SRB	STOJIC Vlaho
3	GER	SCHROEDER Wilhelm
5	AZE	ALISMANOV Shakarhan
6	GRE	KONSTANTINOS Traskas
7	RUS	KARAMATOV Nabi

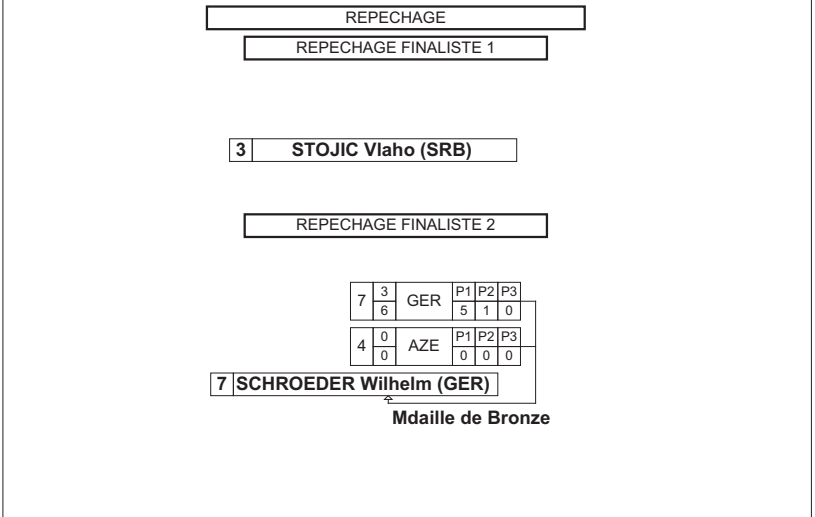



Classement

VETERAN GR WRESTLING WCH - DIVISION "D"



STYLE : GR 85 kg

1 - Or / Gold



KAZAKOV Nikolay

2 - Argent / Silver



BRZOWSKI Zdzislaw

3 - Bronze



STOJIC Vlaho



SCHROEDER Wilhelm

<i>Classement</i>	<i>Nom - Name</i>	<i>Pays - Country</i>
1	KAZAKOV Nikolay	RUS
2	BRZOWSKI Zdzislaw	POL
3	STOJIC Vlaho	SRB
3	SCHROEDER Wilhelm	GER
5	ALISMANOV Shakarhan	AZE
6	KONSTANTINOS T.	GRE
7	KARAMATOV Nabi	RUS



Feuille de compétition / Competition Sheet

VETERAN GR WRESTLING WCH - DIVISION "D"

STYLE : GR 97 kg



TOUR : 1

1	4 8	WIECZORKIEWICZ M. (POL)	P1 2	P2 6	P3 0	1	WIECZORKIEWICZ M. (POL)
2	0 0	NOURBAKHSK Auasgh (IRI)	P1 0	P2 0	P3 0		
3	4 7	GALAMBOS Ferenc (HUN)	P1 3	P2 4	P3 0	3	GALAMBOS Ferenc (HUN)
4	0 0	ALINEJAD A (IRI)	P1 0	P2 0	P3 0		

TOUR : 2

5	0 0	ABDRASHITOV S. (RUS)	P1 0	P2 0	P3 0	1	WIECZORKIEWICZ M. (POL)
1	3 5	WIECZORKIEWICZ M. (POL)	P1 1	P2 4	P3 0		
2	0 0	NOURBAKHSK Auasgh (IRI)	P1 0	P2 0	P3 0	3	GALAMBOS Ferenc (HUN)
3	3 9	GALAMBOS Ferenc (HUN)	P1 7	P2 2	P3 0		

TOUR : 3

4	0 0	ALINEJAD A (IRI)	P1 0	P2 0	P3 0	1	WIECZORKIEWICZ M. (POL)
1	3 8	WIECZORKIEWICZ M. (POL)	P1 2	P2 6	P3 0		
5	3 6	ABDRASHITOV S. (RUS)	P1 5	P2 1	P3 0	5	ABDRASHITOV S. (RUS)
2	0 0	NOURBAKHSK Auasgh (IRI)	P1 0	P2 0	P3 0		

TOUR : 4

3	0 0	GALAMBOS Ferenc (HUN)	P1 0	P2 0	P3 0	1	WIECZORKIEWICZ M. (POL)
1	3 11	WIECZORKIEWICZ M. (POL)	P1 6	P2 5	P3 0		
4	0 0	ALINEJAD A (IRI)	P1 0	P2 0	P3 0	5	ABDRASHITOV S. (RUS)
5	3 4	ABDRASHITOV S. (RUS)	P1 3	P2 1	P3 0		

TOUR : 5

2	0 0	NOURBAKHSK Auasgh (IRI)	P1 0	P2 0	P3 0	4	ALINEJAD A (IRI)
4	3 5	ALINEJAD A (IRI)	P1 3	P2 2	P3 0		
3	1 2	GALAMBOS Ferenc (HUN)	P1 2	P2 0	P3 0	5	ABDRASHITOV S. (RUS)
5	3 5	ABDRASHITOV S. (RUS)	P1 3	P2 2	P3 0		

Classement

Cl	Pays	Nom	Points
1	POL	WIECZORKIEWICZ M.	13
2	RUS	ABDRASHITOV S.	9
3	HUN	GALAMBOS Ferenc	8
4	IRI	ALINEJAD A	3
5	IRI	NOURBAKHSK Auasgh	0



Classement

VETERAN GR WRESTLING WCH - DIVISION "D"



STYLE : GR 97 kg

1 - Or / Gold



WIECZORKIEWICZ Miroslav

2 - Argent / Silver



ABDRASHITOV Safuullov

3 - Bronze



GALAMBOS Ferenc

<i>Classement</i>	<i>Nom - Name</i>	<i>Pays - Country</i>	<i>Points</i>
1	WIECZORKIEWICZ M.	POL	13
2	ABDRASHITOV S.	RUS	9
3	GALAMBOS Ferenc	HUN	8
4	ALINEJAD A	IRI	3
5	NOURBAKHSK Auasgh	IRI	0



Feuille de compétition / Competition Sheet

VETERAN GR WRESTLING WCH - DIVISION "D"

STYLE : GR 130 kg



TOUR : 1

1	3	GHADERI Jamshid (IRI)	P1	P2	P3	1	GHADERI Jamshid (IRI)
	3		2	1	0		
2	0	SHAKIN Anatoly (UKR)	P1	P2	P3	0	
	0		0	0	0		

TOUR : 2

3	3	PISAKIN Alexander (RUS)	P1	P2	P3	3	PISAKIN Alexander (RUS)
	5		4	1	0		
1	0	GHADERI Jamshid (IRI)	P1	P2	P3	0	
	0		0	0	0		

TOUR : 3

2	0	SHAKIN Anatoly (UKR)	P1	P2	P3	0	
	0		0	0	0		
3	3	PISAKIN Alexander (RUS)	P1	P2	P3	3	PISAKIN Alexander (RUS)
	3		1	2	0		

Classement

Cl	Pays	Nom	Points
1	RUS	PISAKIN Alexander	6
2	IRI	GHADERI Jamshid	3
3	UKR	SHAKIN Anatoly	0



Classement

VETERAN GR WRESTLING WCH - DIVISION "D"

STYLE : GR 130 kg



1 - Or / Gold



PISAKIN Alexander

2 - Argent / Silver



GHADERI Jamshid

3 - Bronze



SHAKIN Anatoly

<i>Classement</i>	<i>Nom - Name</i>	<i>Pays - Country</i>	<i>Points</i>
1	PISAKIN Alexander	RUS	6
2	GHADERI Jamshid	IRI	3
3	SHAKIN Anatoly	UKR	0

**Classement par équipe / Teams ranking****VETERAN GR WRESTLING WCH - DIVISION "D"**

STYLE GR



Rang	Equipe	58 KG	63 KG	69 KG	76 KG	85 KG	97 KG	130 KG	TOTAL
1	RUS	9	21	9	14	14	9	10	86
2	IRI	6	29		8		13	9	65
3	POL			9		9	10		28
4	BUL	10		10	6				26
5	UKR				10			8	18
6	GER	8				8			16
7	USA			6	9				15
8	SWE			8	2				10
9	AZE				4	6			10
10	HUN				1		8		9
11	KAZ			8					8
12	SRB					8			8
13	TUR	7							7
14	GRE					5			5
15	LTU			4					4
16	ARG				3				3

VETERAN GR WRESTLING WCH - DIVISION "E"



BELGRADE (SRB)

2010-08-13 - 2010-08-13 2010

Résultats - Results

Lutte Greco-Romaine - Greco-Roman





Liste des arbitres / Referee list

VETERAN GR WRESTLING WCH - DIVISION "E"



<i>N°</i>	<i>Licence</i>	<i>Pays Country</i>	<i>Nom - Last Name</i>	<i>Prénom - First Name</i>
-----------	----------------	-------------------------	------------------------	----------------------------





















Liste des nations / Countries List

VETERAN GR WRESTLING WCH - DIVISION "E"

STYLE GR



Pays - Country

	BELARUS	BLR
	BULGARIA	BUL
	CROATIA	CRO
	EGYPT	EGY
	ESTONIA	EST
	FINLAND	FIN
	GEORGIA	GEO
	GERMANY	GER
	HUNGARY	HUN
	IRAN R.I.	IRI
	ITALY	ITA
	KAZAKHSTAN	KAZ
	RUSSIA	RUS
	SERBIA	SRB
	TURKEY	TUR
	UKRAINE	UKR
	UNITED STATES	USA

Nombre de nations - Number of Countries 17

**Nombre d'engagés par nation / Number of Entries By Country****VETERAN GR WRESTLING WCH - DIVISION "E"**

STYLE GR



<i>Pays - Country</i>	<i>58 KG</i>	<i>63 KG</i>	<i>69 KG</i>	<i>76 KG</i>	<i>85 KG</i>	<i>97 KG</i>	<i>130 KG</i>	<i>TOTAL</i>
BLR		1						1
BUL			1					1
CRO	1	1	2		2	1		7
EGY					1			1
EST				2				2
FIN			1				1	2
GEO	1						1	2
GER	1	1				1		3
HUN				1	1		2	4
IRI	4	2		3	2		3	14
ITA			1					1
KAZ	1				1			2
RUS	2	1		2	1	1	1	8
SRB	1		2		2	2	1	8
TUR		1		1	1	1		4
UKR				1				1
USA	1				1			2
TOTAL	12	7	7	10	12	6	9	63

Nombre de nations - Number of Countries **17**



Liste des Engagés par pays / Entry-List By Country

VETERAN GR WRESTLING WCH - DIVISION "E"

STYLE GR



BELARUS (BLR)

Lutteur(s) / Wrestler(s) :

63 kg BARSHCHAI, Uladzimir

BULGARIA (BUL)

Lutteur(s) / Wrestler(s) :

69 kg PANEV NEDELCHO, Todorov

CROATIA (CRO)

Lutteur(s) / Wrestler(s) :

58 kg LITRA, Djuro
63 kg MEDANCIC, Dusan
69 kg ERAK, Zvonimir
PEKEC, Zdravko
85 kg KOJIC, Vujadin
VUKELIC, Marjan
97 kg CAPIN, Ivica

EGYPT (EGY)

Lutteur(s) / Wrestler(s) :

85 kg MOHAMED, Ahmed

ESTONIA (EST)

Lutteur(s) / Wrestler(s) :

76 kg KIIREND, Olev
TARTLAN, Tiit

FINLAND (FIN)

Lutteur(s) / Wrestler(s) :

69 kg VEIKKO, Timo
130 kg MARTII MAKI, Hakola

GEORGIA (GEO)

Lutteur(s) / Wrestler(s) :

58 kg ROBAKIDZE, Grigol



Liste des Engagés par pays / Entry-List By Country

VETERAN GR WRESTLING WCH - DIVISION "E"

STYLE GR



130 kg

GOGLECHIDZE, Estate

GERMANY (GER)

Lutteur(s) / Wrestler(s) :

58 kg

KOCH, Werner

63 kg

HECKMANN, Peter

97 kg

ARTUR, Sammet

HUNGARY (HUN)

Lutteur(s) / Wrestler(s) :

76 kg

VARGA, Jozef

85 kg

SZARAZ, Ferenc

130 kg

KOLLARIK, Mihaly
WAGNER, Mihaly

IRAN R.I. (IRI)

Lutteur(s) / Wrestler(s) :

58 kg

ABEDINI, Ghasem
MOAREFIYANPOUR, Abdolrahman
SOLTANABADI, Ahmad
TAHERI ALI, Mohammad

63 kg

ALLAHVERDI, Nader
AZAMMORADI, Abbas

76 kg

BEHNOUD MOHAMMAD, Hasan
GHANBARI, Mahmoud
HEYBAT ALI ZARGARI, Pour

85 kg

SIAPOSHT, A
TARAJ, Mahmoud

130 kg

AKBAR, A
ARSHADI, P
MASOUD, Mogharebi

ITALY (ITA)

Lutteur(s) / Wrestler(s) :

69 kg

MARCHI, Daniele

KAZAKHSTAN (KAZ)

Lutteur(s) / Wrestler(s) :

58 kg

CHSHERBAKOV, Vladimir



Liste des Engagés par pays / Entry-List By Country

VETERAN GR WRESTLING WCH - DIVISION "E"



STYLE GR

85 kg KLIMOV, Sergey

RUSSIA (RUS)

Lutteur(s) / Wrestler(s) :

58 kg	CHIRKOV, Viktor KOTERKOV, Alehander
63 kg	AKOPNIN, Mikhail
76 kg	GALEEV, Tagir KATAEV, Mikhail
85 kg	LI-YU, Pavel
97 kg	BOCKAREV, Vladimir
130 kg	KRASNOV, Alexander

SERBIA (SRB)

Lutteur(s) / Wrestler(s) :

58 kg	SKUSEK, Slavko
69 kg	DELIC, Jefta HUSAR, Laslo
85 kg	KONC, Ištvan STOJIC, Dragomir
97 kg	CVIJOVIC, Vu?eta ZATEZALO, Savo
130 kg	JERKOVIC, Mirko

TURKEY (TUR)

Lutteur(s) / Wrestler(s) :

63 kg	SEYFI, Karadavut
76 kg	SAHIN, Ahmet
85 kg	SALIH, Karakus
97 kg	KAYA, Uygur

UKRAINE (UKR)

Lutteur(s) / Wrestler(s) :

76 kg	ANATOLIY, Samokha
-------	-------------------

UNITED STATES (USA)

Lutteur(s) / Wrestler(s) :



Liste des Engagés par pays / Entry-List By Country

VETERAN GR WRESTLING WCH - DIVISION "E"

STYLE GR



58 kg

SCHARTNER, James

85 kg

CONTARINO, Stephen



Classement par équipe / Teams ranking

VETERAN GR WRESTLING WCH - DIVISION "E"



STYLE : GR 58 kg



2 MOAREFIYANPOUR A. (IRI)

Classement

Cl	Pays	Nom
1	IRI	MOAREFIYANPOUR Abdolrahman
2	RUS	CHIRKOV Viktor
3	KAZ	CHSHERBAKOV V.
3	RUS	KOTERKOV Alehander
5	IRI	TAHERI ALI Mohammad
5	IRI	ABEDINI Ghasem
7	IRI	SOLTAN BADI Ahmad
8	CRO	LITRA Djuro
9	GEO	ROBAKIDZE Grighmediol
10	GER	KOCH Werner
11	USA	SCHARTNER James
12	SRB	SKUSEK Slavko

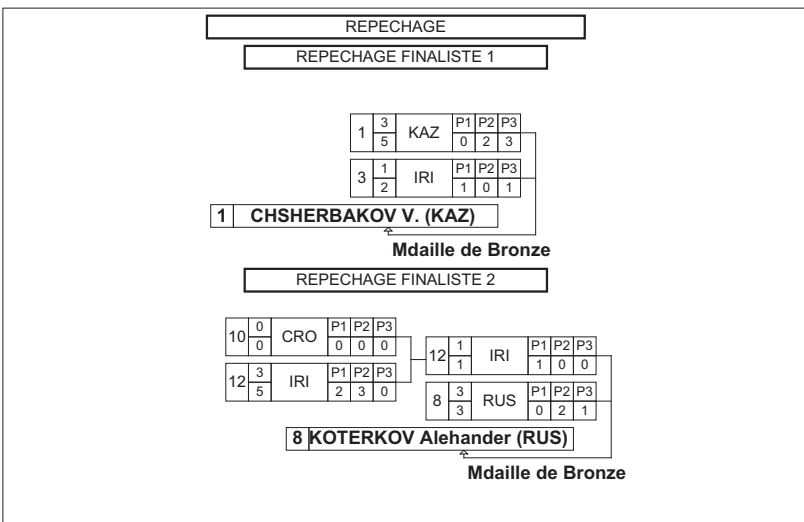

**Classement par équipe / Teams ranking****VETERAN GR WRESTLING WCH - DIVISION "E"**

STYLE : GR 58 kg

1 - Or / Gold



MOAREFIYANPOUR Abdolrahman

2 - Argent / Silver



CHIRKOV Viktor

3 - Bronze



CHSHERBAKOV Vladimir KOTERKOV Alehander

Classement	Nom - Name	Pays - Country
1	MOAREFIYANPOUR A.	IRI
2	CHIRKOV Viktor	RUS
3	CHSHERBAKOV Vladimir	KAZ
3	KOTERKOV Alehander	RUS
5	TAHERI ALI Mohammad	IRI
5	ABEDINI Ghasem	IRI
7	SOLTAN BADI Ahmad	IRI
8	LITRA Djuro	CRO
9	ROBAKIDZE Grigol	GEO
10	KOCH Werner	GER
11	SCHARTNER James	USA
12	SKUSEK Slavko	SRB



Feuille de compétition / Competition Sheet

VETERAN GR WRESTLING WCH - DIVISION "E"



STYLE : GR 63 kg

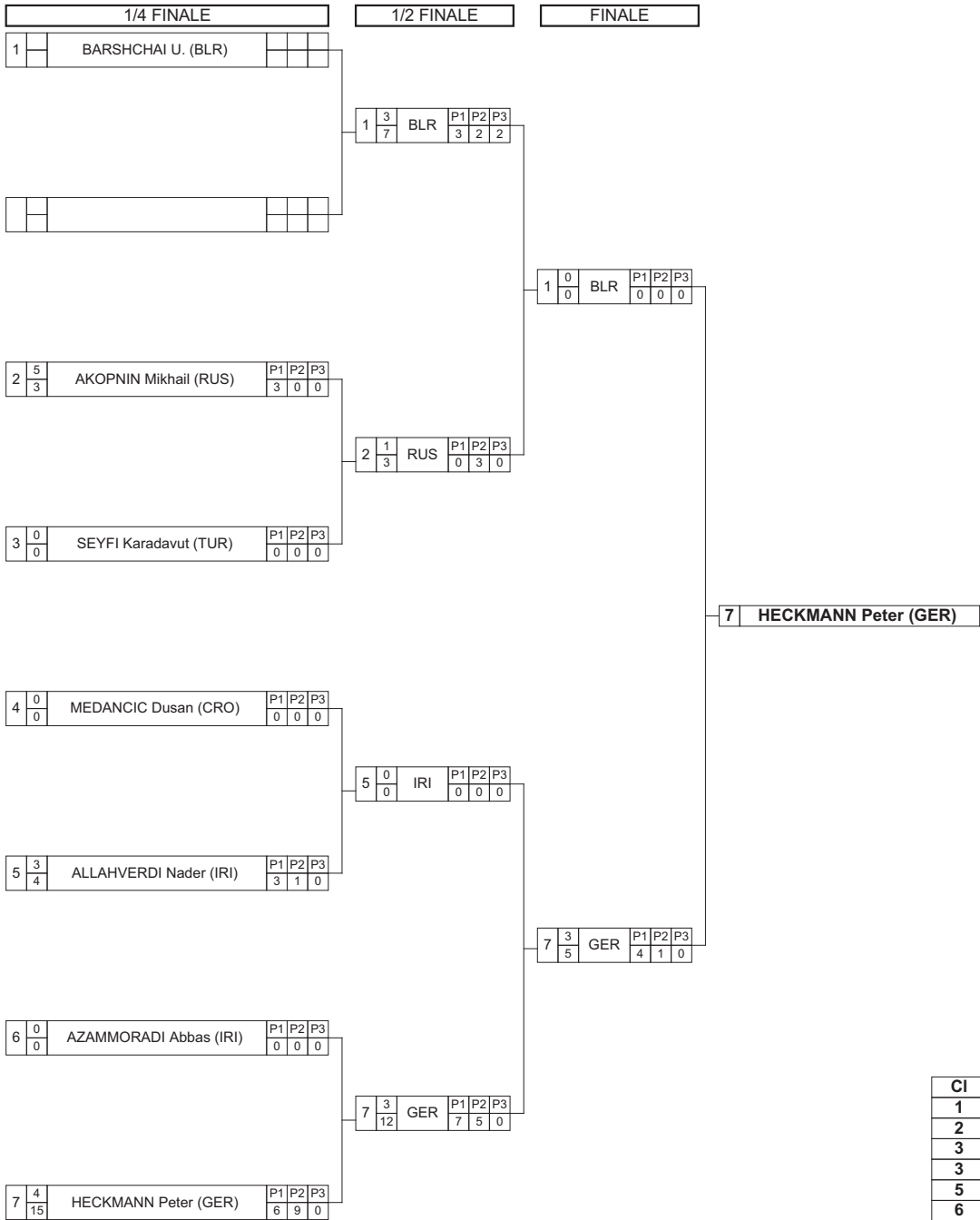

Classement

Cl	Pays	Nom
1	GER	HECKMANN Peter
2	BLR	BARSHCHAI Uladzimir
3	RUS	AKOPNIN Mikhail
3	IRI	ALLAHVERDI Nader
5	IRI	AZAMMORADI Abbas
6	TUR	SEYFI Karadavut
7	CRO	MEDANCIC Dusan

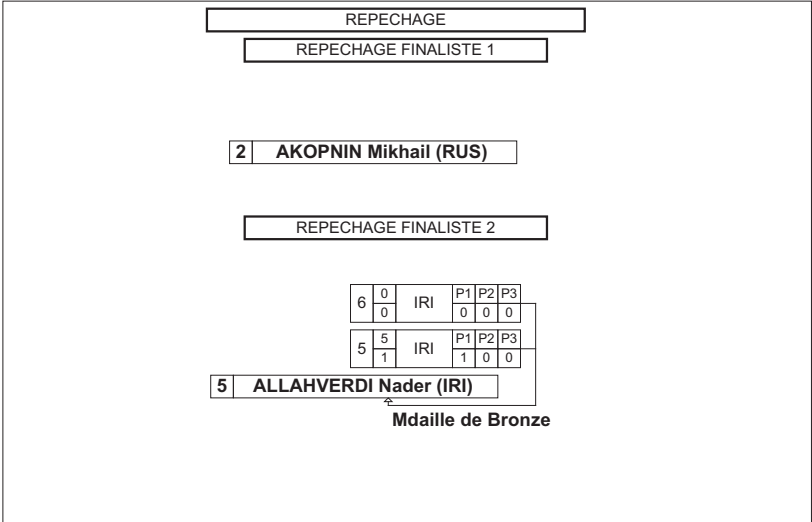



Classement

VETERAN GR WRESTLING WCH - DIVISION "E"

STYLE : GR 63 kg



1 - Or / Gold



HECKMANN Peter

2 - Argent / Silver



BARSHCHAI Uladzimir

3 - Bronze



AKOPNIN Mikhail



ALLAHVERDI Nader

Classement	Nom - Name	Pays - Country
1	HECKMANN Peter	GER
2	BARSHCHAI Uladzimir	BLR
3	AKOPNIN Mikhail	RUS
3	ALLAHVERDI Nader	IRI
5	AZAMMORADI Abbas	IRI
6	SEYFI Karadavut	TUR
7	MEDANCIC Dusan	CRO



Feuille de compétition / Competition Sheet

VETERAN GR WRESTLING WCH - DIVISION "E"



STYLE : GR 69 kg

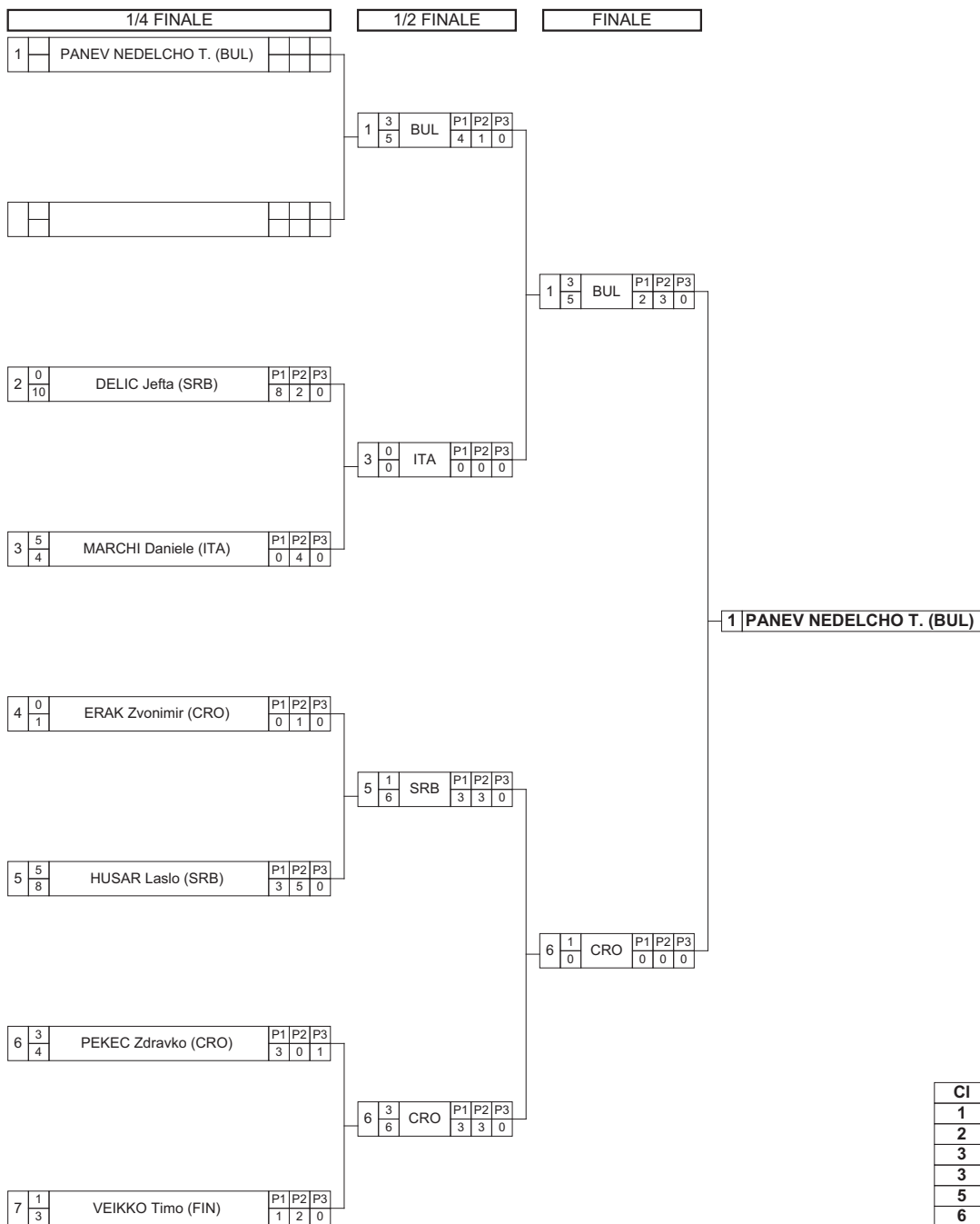

Classement

Cl	Pays	Nom
1	BUL	PANEV NEDELCHO Todorov
2	CRO	PEKEC Zdravko
3	ITA	MARCHI Daniele
3	SRB	HUSAR Laslo
5	FIN	VEIKKO Timo
6	SRB	DELIC Jefta
7	CRO	ERAK Zvonimir

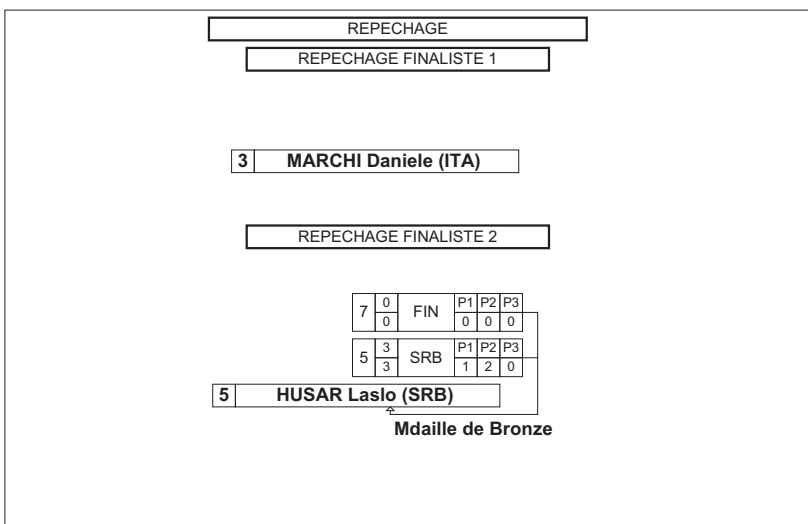



Classement

VETERAN GR WRESTLING WCH - DIVISION "E"



STYLE : GR 69 kg

1 - Or / Gold



PANEV NEDELCHO Todorov

2 - Argent / Silver



PEKEC Zdravko

3 - Bronze



MARCHI Daniele



HUSAR Laslo

<i>Classement</i>	<i>Nom - Name</i>	<i>Pays - Country</i>
1	PANEV NEDELCHO T.	BUL
2	PEKEC Zdravko	CRO
3	MARCHI Daniele	ITA
3	HUSAR Laslo	SRB
5	VEIKKO Timo	FIN
6	DELIC Jefta	SRB
7	ERAK Zvonimir	CRO



Feuille de compétition / Competition Sheet

VETERAN GR WRESTLING WCH - DIVISION "E"



STYLE : GR 76 kg

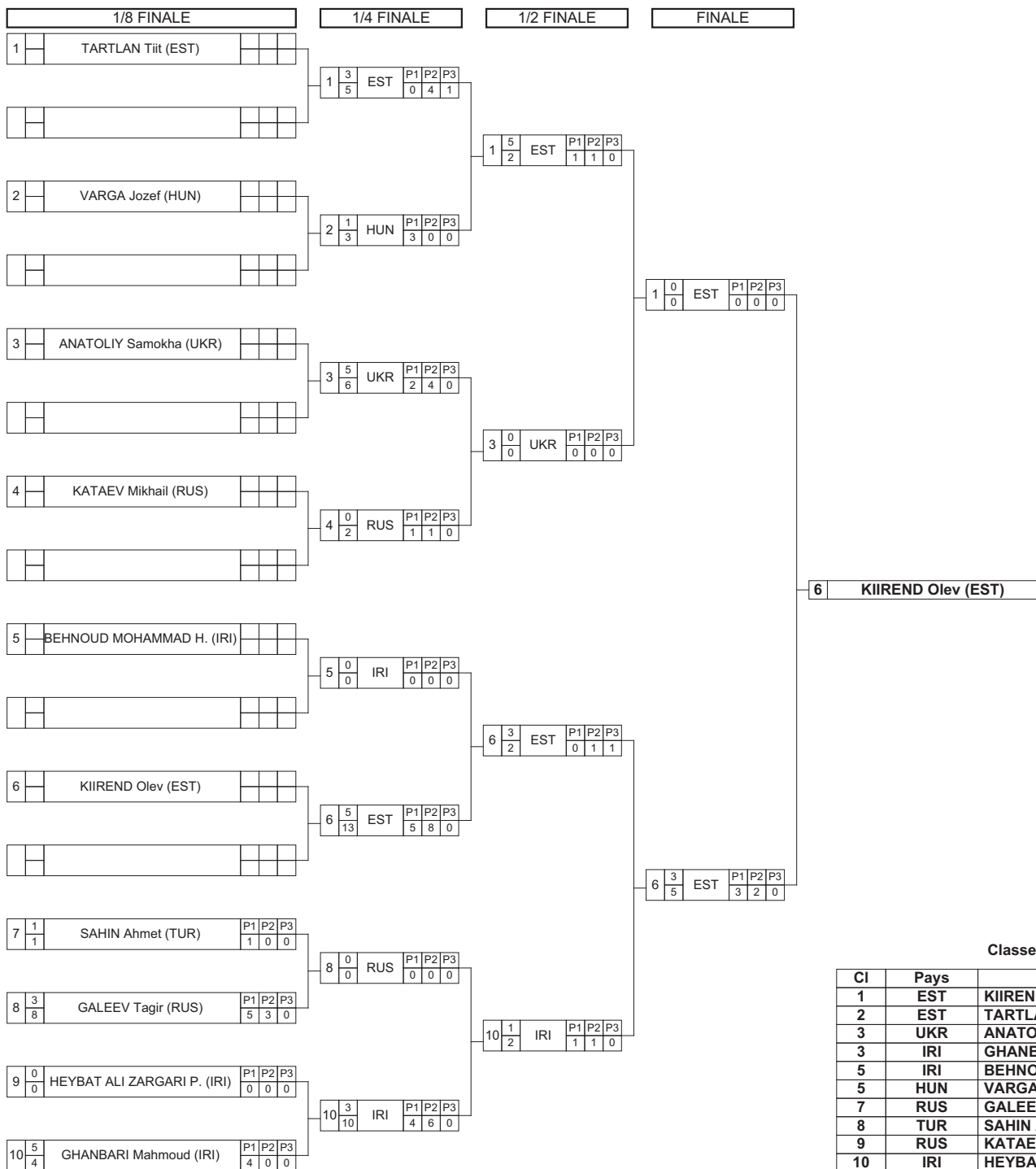

Classement

Cl	Pays	Nom
1	EST	KIIREND Olev
2	EST	TARTLAN Tiit
3	UKR	ANATOLIY Samokha
3	IRI	GHANBARI Mahmoud
5	IRI	BEHNOUD MOHAMMAD Hasan
5	HUN	VARGA Jozef
7	RUS	GALEEV Tagir
8	TUR	SAHIN Ahmet
9	RUS	KATAEV Mikhail
10	IRI	HEYBAT ALI ZARGARI Pour

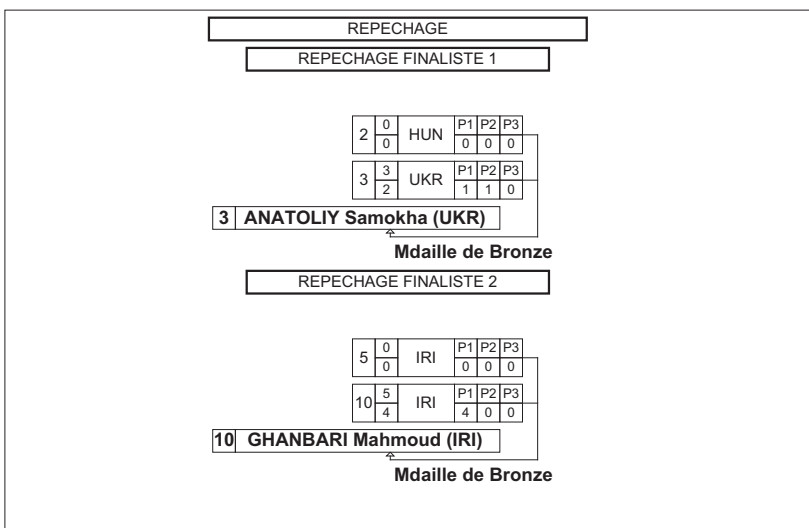



Classement

VETERAN GR WRESTLING WCH - DIVISION "E"

STYLE : GR 76 kg



1 - Or / Gold



KIIREND Olev

2 - Argent / Silver



TARTLAN Tiit

3 - Bronze



ANATOLIY Samokha



GHANBARI Mahmoud

Classement	Nom - Name	Pays - Country
1	KIIREND Olev	EST
2	TARTLAN Tiit	EST
3	ANATOLIY Samokha	UKR
3	GHANBARI Mahmoud	IRI
5	BEHNOUD MOHAMMAD H.	IRI
5	VARGA Jozef	HUN
7	GALEEV Tagir	RUS
8	SAHIN Ahmet	TUR
9	KATAEV Mikhail	RUS
10	HEYBAT ALI ZARGARI P.	IRI



Feuille de compétition / Competition Sheet

VETERAN GR WRESTLING WCH - DIVISION "E"



STYLE : GR 85 kg

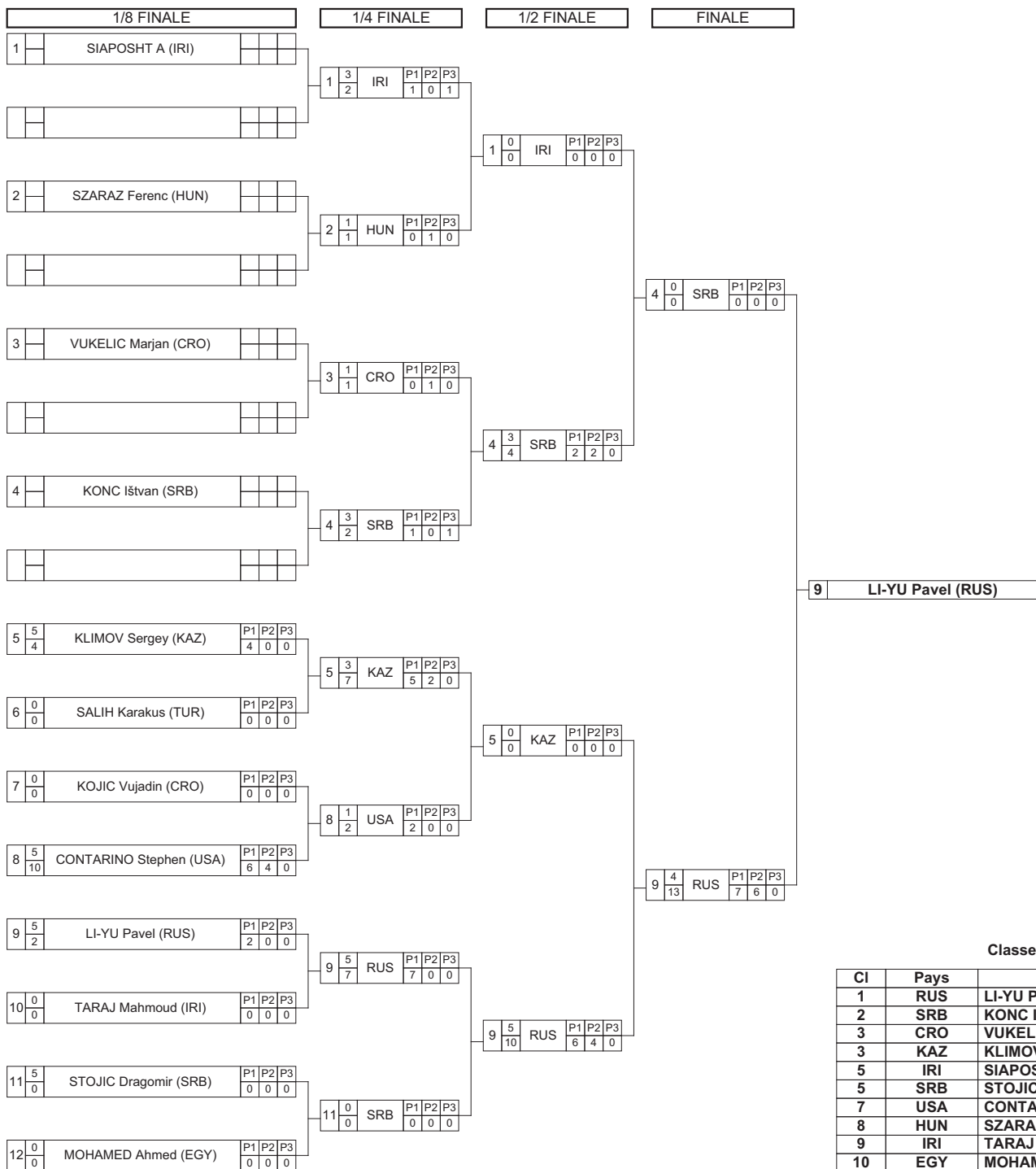

Classement

Cl	Pays	Nom
1	RUS	LI-YU Pavel
2	SRB	KONC Istvan
3	CRO	VUKELIC Marjan
3	KAZ	KLIMOV Sergey
5	IRI	SIAPOSHT A
5	SRB	STOJIC Dragomir
7	USA	CONTARINO Stephen
8	HUN	SZARAZ Ferenc
9	IRI	TARAJ Mahmoud
10	EGY	MOHAMED Ahmed
11	TUR	SALIH Karakus
12	CRO	KOJIC Vujadin

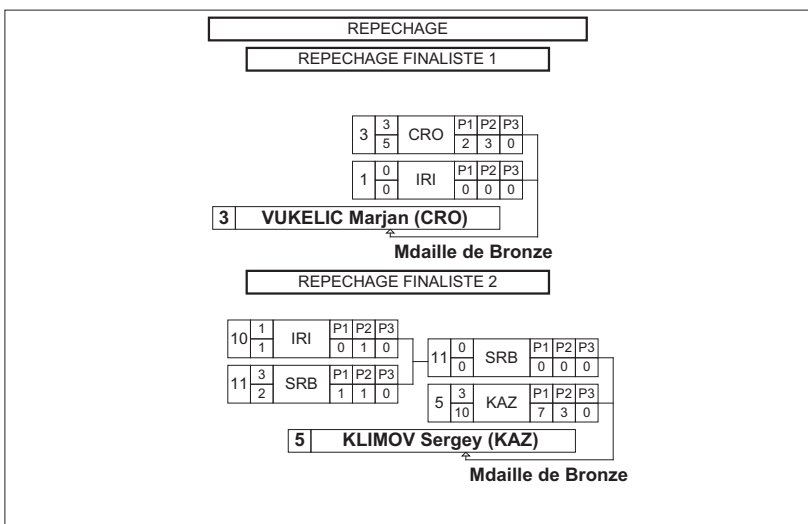



Classement

VETERAN GR WRESTLING WCH - DIVISION "E"

STYLE : GR 85 kg



1 - Or / Gold



LI-YU Pavel

2 - Argent / Silver



KONC Ištvan

3 - Bronze



VUKELIC Marjan



KLIMOV Sergey

Classement	Nom - Name	Pays - Country
1	LI-YU Pavel	RUS
2	KONC Ištvan	SRB
3	VUKELIC Marjan	CRO
3	KLIMOV Sergey	KAZ
5	SIAPOSHT A	IRI
5	STOJIC Dragomir	SRB
7	CONTARINO Stephen	USA
8	SZARAZ Ferenc	HUN
9	TARAJ Mahmoud	IRI
10	MOHAMED Ahmed	EGY
11	SALIH Karakus	TUR
12	KOJIC Vujadin	CRO



Classement

VETERAN GR WRESTLING WCH - DIVISION "E"



STYLE : GR 97 kg

1 - Or / Gold



BOCKAREV Vladimir

2 - Argent / Silver



ARTUR Sammet

3 - Bronze



ZATEZALO Savo



CVIJOVIC Vu?eta

<i>Classement</i>	<i>Nom - Name</i>	<i>Pays - Country</i>
1	BOCKAREV Vladimir	RUS
2	ARTUR Sammet	GER
3	ZATEZALO Savo	SRB
3	CVIJOVIC Vu?eta	SRB
5	KAYA Uygur	TUR
6	CAPIN Ivica	CRO



Feuille de compétition / Competition Sheet

VETERAN GR WRESTLING WCH - DIVISION "E"



STYLE : GR 130 kg

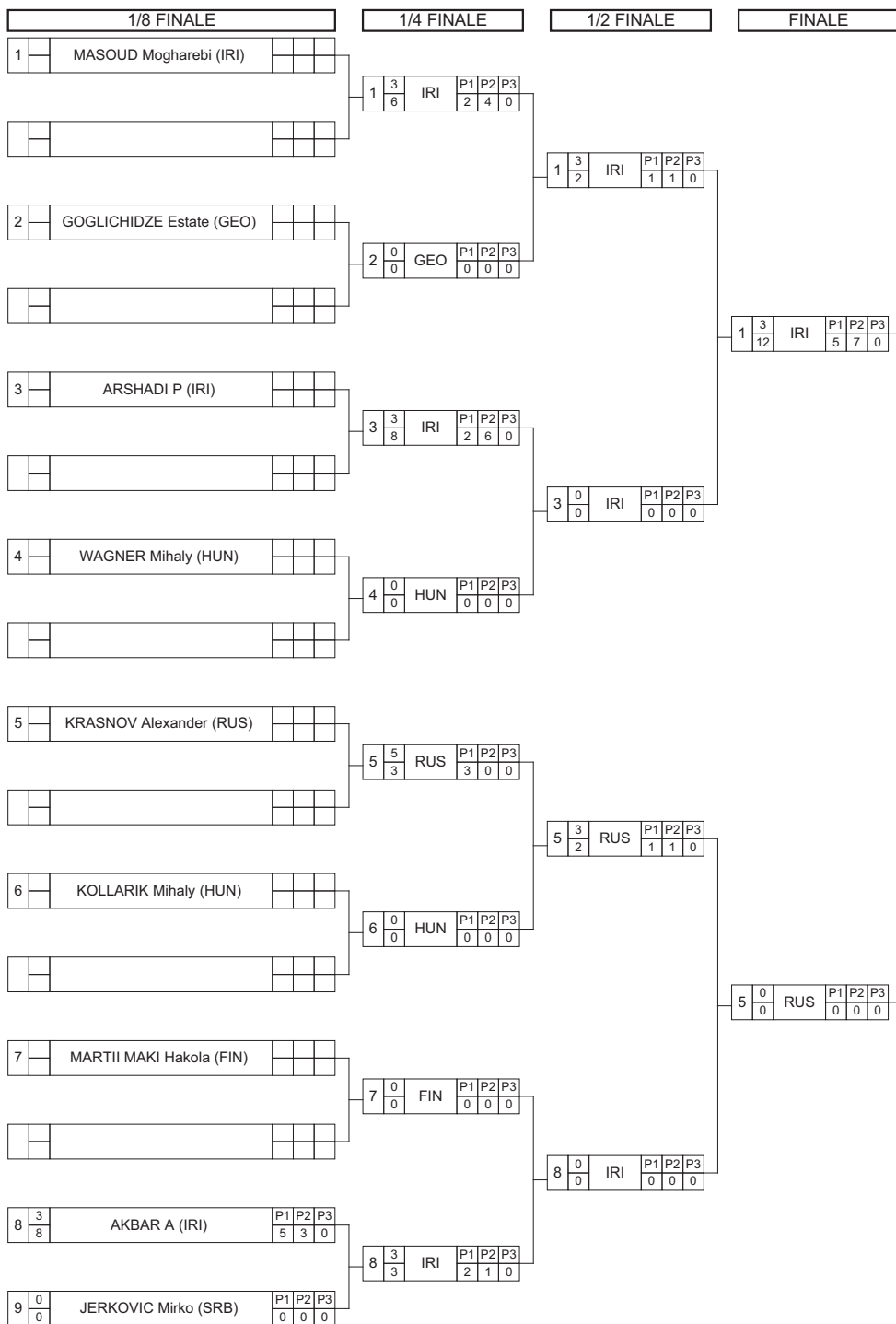

Classement

Cl	Pays	Nom
1	IRI	MASOUD Mogharebi
2	RUS	KRASNOV Alexander
3	GEO	GOGLICHIDZE Estate
3	IRI	AKBAR A
5	IRI	ARSHADI P
5	HUN	KOLLARIK Mihaly
7	FIN	MARTII MAKI Hakola
8	SRB	JERKOVIC Mirko
9	HUN	WAGNER Mihaly

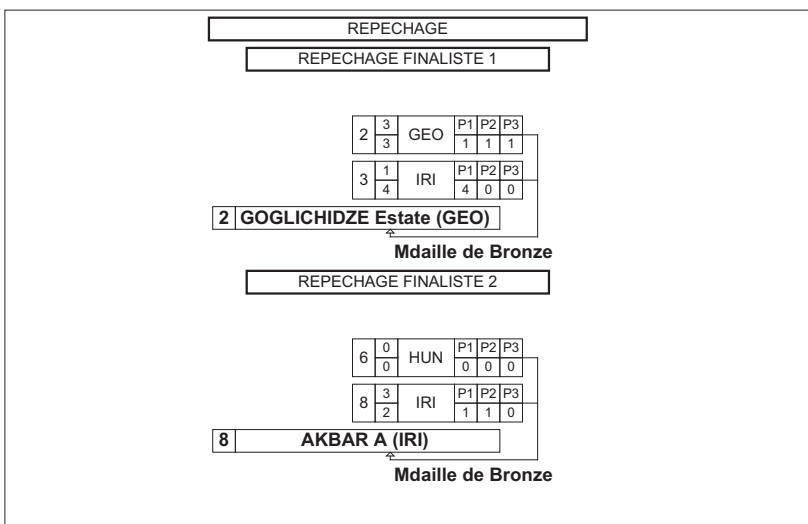



Classement

VETERAN GR WRESTLING WCH - DIVISION "E"

STYLE : GR 130 kg



1 - Or / Gold



MASOUD Mogharebi

2 - Argent / Silver



KRASNOV Alexander

3 - Bronze



GOGLICHIDZE Estate



AKBAR A

Classement	Nom - Name	Pays - Country
1	MASOUD Mogharebi	IRI
2	KRASNOV Alexander	RUS
3	GOGLICHIDZE Estate	GEO
3	AKBAR A	IRI
5	ARSHADI P	IRI
5	KOLLARIK Mihaly	HUN
7	MARTII MAKI Hakola	FIN
8	JERKOVIC Mirko	SRB
9	WAGNER Mihaly	HUN

**Classement par équipe / Teams ranking****VETERAN GR WRESTLING WCH - DIVISION "E"****STYLE GR**

Rang	Equipe	58 KG	63 KG	69 KG	76 KG	85 KG	97 KG	130 KG	TOTAL
1	IRI	24	14		15	8		24	85
2	RUS	13	8		6	10	10	9	56
3	SRB			13		15	16	3	47
4	CRO	3	4	13		8	5		33
5	GER	1	10				9		20
6	EST				19				19
7	HUN				6	3		8	17
8	KAZ	8				8			16
9	TUR		5		3		6		14
10	BUL			10					10
11	GEO	2						8	10
12	FIN			6				4	10
13	BLR		9						9
14	ITA			8					8
15	UKR				8				8
16	USA					4			4
17	EGY					1			1



12th VETERAN GR WRESTLING WORLD CHAMPIONSHIP

TEAM STANDING

<i>Pays - Country</i>		<i>Div.A</i>	<i>Div.B</i>	<i>Div.C</i>	<i>Div.D</i>	<i>Div.E</i>	<i>TOTAL</i>
1	IRI	107	94	87	65	85	438
2	RUS	60	85	87	86	56	374
3	UKR	27	15	28	18	8	96
4	BUL	4	36	16	26	10	92
5	GER	10	6	31	16	20	83
6	SRB	14	12		8	47	81
7	KAZ	39		14	8	16	77
8	HUN		22	14	9	17	62
9	SWE	10	20	18	10		58
10	NOR	16	23	10			49
11	CRO	1	14			33	48
12	EST		17	7		19	43
13	TUR	1	19	2	7	14	43
14	ITA	6	8	16		8	38
15	POL			6	28		34
16	FIN	10	6			10	26
17	AZE			13	10		23
18	USA	3	1		15	4	23
19	BIH	16					16
20	BLR			6		9	15
21	SLO		6	6			12
22	GRE	6			5		11
23	FRA	8	3				11
24	GEO					10	10
25	DEN			9			9
26	CZE	9					9
27	LTU			3	4		7
28	ARM	6					6
29	LAT	4					4
30	ARG				3		3
31	EGY					1	1
TOTAL		357	387	373	318	367	1802